



OEM Manufacturer & Global Supplier of
Lockout Tagout & Safety Products

to meet
OSHA'S Lockout Tagout Standard
29 CFR, 1910.147&1910.269



www.lockoutappliances.com

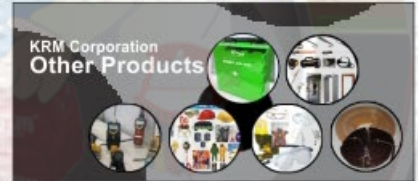



OEM Manufacturer & Global Supplier of
Lockout Tagout & Safety Products

to meet
OSHA'S Lockout Tagout Standard
29 CFR, 1910.147&1910.269



www.locktagindia.com



DOUBLE BODY – OSHA SAFETY LOCK TAG PADLOCK

Index Page No:-2

SR.NO	KRM LOTO PART CODE	PRODUCT NAME	WEIGHT (kg)	TECHNICAL PAGE NO.
1	KRM-K-DB-OSLTP-MSDK	DOUBLE BODY – OSHA SAFETY LOCK TAG PADLOCK – METAL SHACKLE DIFFER KEY	0.170	3-4
2	KRM-K-DB-OSLTP-MSDK+M	DOUBLE BODY – OSHA SAFETY LOCK TAG PADLOCK – METAL SHACKLE DIFFER + MASTER KEY	0.170	3-4
3	KRM-K-DB-OSLTP-MLDK	DOUBLE BODY – OSHA SAFETY LOCK TAG PADLOCK – METAL LONG SHACKLE DIFFER KEY	0.195	5-6
4	KRM-K-DB-OSLTP-MLDK+M	DOUBLE BODY – OSHA SAFETY LOCK TAG PADLOCK – METAL LONG SHACKLE IFFER + MASTER KEY	0.195	5-6
5		FEATURE OF OSHA LOCKS		7-8



OEM Manufacturer & Global Supplier of
 Lockout Tagout & Safety Products

to meet
 OSHA'S Lockout Tagout Standard
 29 CFR, 1910.147&1910.269



DOUBLE BODY – OSHA SAFETY LOCK TAG PADLOCK – METAL SHACKLE

- Padlock Is a detachable Lock Passed By An Opening With U-shaped Shackle Used To Protect Against Unauthorized Or Unwanted Stealing. Provided With Latest Locking Mechanism Used To Lock The Different Devices.
- KRM LOTO SAFETY PADLOCK ---"seamless" lock structure durability-Key system: DIFFER KEY, ALIKE KEY, MASTER & DIFFER KEY. The new management key technology,- 10 level management.
- To meet OSHA standard for The Control of Hazardous Energy (Lockout/Tagout), Title **29 Code of Federal Regulations(CFR)Part 1910.147**
- With a curve at top to hold the lock with better grip
- Key Head in injection mold with same color of the lock.
- Key retaining-ensures that padlock is not left unlocked.
- Configuration key card, easy to know personal ID, indicating the corresponding padlock for easy management.
- Key system: **DIFFER KEY, ALIKE KEY, MASTER & DIFFER KEY.**
- **Body material** – Glass fiber reinforced nylon/(composition of ABS+NYLON)
- **Shackle Material** – Metal Shackle
- **Color** – Red, Yellow, Blue, Green, Orange, White, Brown, Black, Purple
- Work temperature 0o - 250o F (-20o - 120o C)
- Also **"DO NOT REMOVE"**, permanently engraved on the lock.
- **Weight** – 170 gm

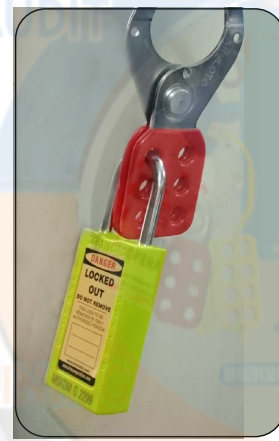

KRM-K-DB-OSLTP-MSDK



BODY HEIGHT (A)	BODY WIDTH (B)	BODY DEPTH (C)	SHACKLE HEIGHT (D)	SHACLE WIDTH (E)	SHACKLE THICKNESS (F)
75 mm	38 mm	20 mm	38 mm	20 mm	6 mm

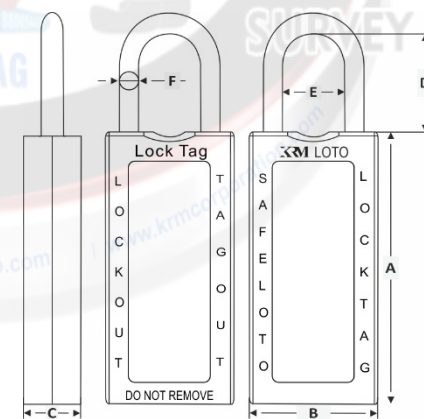



OEM Manufacturer & Global Supplier of
Lockout Tagout & Safety Products

to meet
OSHA'S Lockout Tagout Standard
29 CFR, 1910.147&1910.269



www.locktagindia.com



Regd. Office: 1H/31-A, N.I.T, Faridabad-121001 (Haryana) Postal Office: 615, Sector-15-A, Faridabad-121007-Haryana-NCR-INDIA

Email: info@krmloto.com, info@krmcorporation.com, krmloto@gmail.com

LOCKOUT/TAGOUT



DOUBLE BODY – OSHA SAFETY LOCK TAG PADLOCKS – METAL REGULAR SHACKLE

CE Certified

Padlock Is a detachable Lock Passed By An Opening With U-shaped Shackle Used To Protect Against Unauthorized Or Unwanted Stealing. Provided With **Latest Locking Mechanism** Used To Lock The Different Devices.

- KRM LOTO SAFETY PADLOCK ----"seamless" lock structure durability-Key system: **DIFFER KEY, ALIKE KEY, MASTER & DIFFER KEY.** The new management key technology,- 10 level management.
- To meet OSHA standard for The Control of Hazardous Energy (Lockout/Tagout), Title **29 Code of Federal Regulations(CFR)Part 1910.147**
- With a curve at top to hold the lock with better grip
- Key Head in injection mold with same color of the lock.
- Key retaining-ensures that padlock is not left unlocked.
- Configuration key card, easy to know personal ID, indicating the corresponding padlock for easy management.
- **Key system:** DIFFER KEY, ALIKE KEY, MASTER & DIFFER KEY.
- **Body material** – Glass fiber reinforced nylon/(composition of ABS+NYLON)
- **Shackle Material** – Metal Shackle
- **Color** – Red, Yellow, Blue, Green, Orange, White, Brown, Black, Purple
- Work temperature 0° - 250° F (-20° - 120° C)
- Also "DO NOT REMOVE", permanently engraved on the lock.
- **Weight** – 170 gm

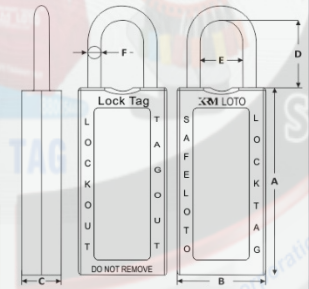
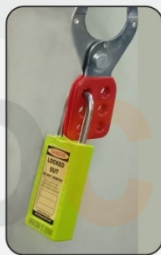

KRM-K-DB-OSLTP-MSDK

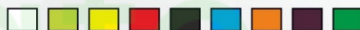

ITEM CODE	BODY HEIGHT (A)	BODY WIDTH (B)	BODY DEPTH (C)	SHACKLE HEIGHT (D)	SHACKLE WIDTH (E)	SHACKLE THICKNESS (F)
KRM-K-DB-OSLTP-MSDK	75 mm	38 mm	20 mm	38 mm	20 mm	6 mm



OEM Manufacturer & Global Supplier of
 Lockout Tagout & Safety Products

to meet
 OSHA'S Lockout Tagout Standard
 29 CFR, 1910.147&1910.269



www.lotoappliances.com



DOUBLE BODY – OSHA SAFETY LOCK TAG PADLOCK – METAL LONG SHACKLE

- Padlock Is a detachable Lock Passed By An Opening With U-shaped Shackle Used To Protect Against Unauthorized Or Unwanted Stealing. Provided With Latest Locking Mechanism Used To Lock The Different Devices.
- KRM LOTO SAFETY PADLOCK ---"seamless" lock structure durability-Key system: DIFFER KEY, ALIKE KEY, MASTER & DIFFER KEY. The new management key technology,- 10 level management.
- To meet OSHA standard for The Control of Hazardous Energy (Lockout/Tagout), Title 29 Code of Federal Regulations(CFR)Part 1910.147
- With a curve at top to hold the lock with better grip
- Key Head in injection mold with same color of the lock.
- Key retaining-ensures that padlock is not left unlocked.
- Configuration key card, easy to know personal ID, indicating the corresponding padlock for easy management.
- Key system: **DIFFER KEY, ALIKE KEY, MASTER & DIFFER KEY.**
- **Body material:** Glass fiber reinforced nylon/(composition of ABS+NYLON)
- **Shackle Material:** Metal Shackle
- **Color –** Red, Yellow, Blue, Green, Orange, White, Brown, Black, Purple
- Work temperature 0o - 250o F (-20o - 120o C)
- Also "DO NOT REMOVE", permanently engraved on the lock.
- **Weight –** 195gm



KRM-K-DB-OSLTP-MLDK

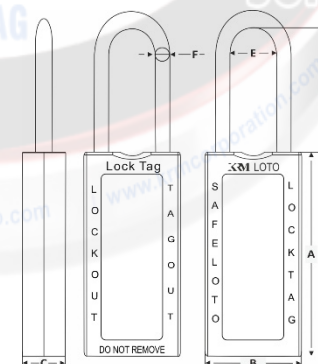

BODY HEIGHT (A)	BODY WIDTH (B)	BODY DEPTH (C)	SHACKLE HEIGHT (D)	SHACLE WIDTH (E)	SHACKLE THICKNESS (F)
75 mm	38 mm	20 mm	76 mm	20 mm	6 mm



OEM Manufacturer & Global Supplier of
Lockout Tagout & Safety Products

to meet
OSHA'S Lockout Tagout Standard
29 CFR, 1910.147&1910.269



www.locktagindia.com



Regd. Office: 1H/31-A, N.I.T, Faridabad-121001 (Haryana) | Postal Office: 615, Sector-15-A, Faridabad-121007-Haryana-NCR-INDIA

www.krmcorporation.com | www.lockouttagouts.com | www.krmloto.com | www.locktagindia.com | www.lotoappliances.com

LOCKOUT/TAGOUT



DOUBLE BODY – OSHA SAFETY LOCK TAG PADLOCKS – METAL LONG SHACKLE

CE Certified

Padlock Is a detachable Lock Passed By An Opening With U-shaped Shackle Used To Protect Against Unauthorized Or Unwanted Stealing. Provided With **Latest Locking Mechanism** Used To Lock The Different Devices.

- KRM LOTO SAFETY PADLOCK ---"seamless" lock structure durability-Key system: **DIFFER KEY, ALIKE KEY, MASTER & DIFFER KEY.** The new management key technology,- 10 level management.
- To meet OSHA standard for The Control of Hazardous Energy (Lockout/Tagout), Title **29 Code of Federal Regulations(CFR)Part 1910.147**
- With a curve at top to hold the lock with better grip
- Key Head in injection mold with same color of the lock.
- Key retaining-ensures that padlock is not left unlocked.
- Configuration key card, easy to know personal ID, indicating the corresponding padlock for easy management.
- **Key system:** DIFFER KEY, ALIKE KEY, MASTER & DIFFER KEY.
- **Body material:** Glass fiber reinforced nylon/(composition of ABS+NYLON)
- **Shackle Material:** Metal Shackle
- **Color –** Red, Yellow, Blue, Green, Orange, White, Brown, Black, Purple
- Work temperature 0° - 250° F (-20° - 120° C)
- Also **"DO NOT REMOVE"**, permanently engraved on the lock.
- **Weight –** 195gm



KRM-K-DB-OSLTP-MLDK

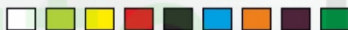

ITEM CODE	BODY HEIGHT (A)	BODY WIDTH (B)	BODY DEPTH (C)	SHACKLE HEIGHT (D)	SHACKLE WIDTH (E)	SHACKLE THICKNESS (F)
KRM-K-DB-OSLTP-MLDK	75 mm	38 mm	20 mm	76 mm	20 mm	6 mm

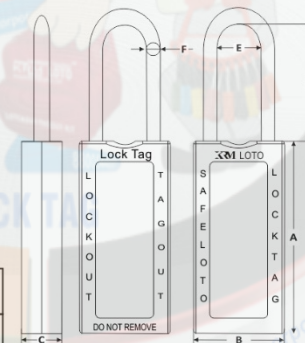

GSTIN No.: 06AAPW8746Q1Z6,
PAN No.: AAVPW8746Q
TIN No.: 06821328889,
TAN no.: RTKKO3359G
IEC: 0509006116

M: 00 91 9810 291 381, 8900 544 881



OEM Manufacturer & Global Supplier of
Lockout Tagout & Safety Products

to meet
OSHA'S Lockout Tagout Standard
29 CFR, 1910.147&1910.269



www.lotoappliances.com



GSTIN No.: 06AAECK2831L1Z1
PAN No.: AAECK2831L
TIN No.: 06824000112
CIN No.: U31903HR2011PTC042508
IEC: AAECK2831L

Telefax: 00 91 129 4021 381, 413 1381 (D)

Regd. Office: 1H/31-A, N.I.T, Faridabad-121001 (Haryana) Postal Office: 615, Sector-15-A, Faridabad-121007-Haryana-NCR-INDIA

www.krmcorporation.com | www.lockouttagouts.com | www.krmloto.com | www.locktagindia.com | www.lotoappliances.com

SPECIAL FEATURE of OSHA Safety Lock Tag Padlock :

- High quality isolation padlock as per isolation guidelines to meet OSHA requirements
- Key retained in unlock condition that means key would not come out & the Key can be removed in only lock position.
- It is suitable for both low and high temperature.
- Particular key for particular padlock.
- No key mixing with any other lock.
- Key mechanism- differ key , alike key , master key available on demand. The new management key technology – 6/10 level management.
- Each lock with specific numbering on body of lock and key.
- Shackle – 25/38/76mm
- Standard shackle, long shackle in Metal/Dielectric shackle available
- Electric current resist from shackle to key, in case of dielectric shackle .
- Main advantage of nylon shackle , in case of emergency, shackle can be cut easily.



OEM Manufacturer & Global Supplier of
Lockout Tagout & Safety Products

to meet
OSHA'S Lockout Tagout Standard
29 CFR, 1910.147&1910.269



www.lotoappliances.com



GSTIN No.: 06AAECK2831L1Z1
PAN No.: AAECK2831L
TIN No.: 06824000112
CIN No.: U31903HR2011PTC042508
IEC: AAECK2831L

Telefax: 00 91 129 4021 381, 413 1381 (D)

Regd. Office:1H/31-A, N.I.T, Faridabad-121001 (Haryana) Postal Office:615, Sector-15-A, Faridabad-121007-Haryana-NCR-INDIA

www.krmcorporation.com | www.lockouttagouts.com | www.krmloto.com | www.locktagindia.com | www.lotoappliances.com

SPECIAL FEATURE OF OSHA SAFETY LOCK TAG PADLOCKS

CE Certified

- High quality isolation padlock as per isolation guidelines to meet OSHA requirements
- Key retained in unlock condition that means key would not come out & the Key can be removed in only lock position.
- It is suitable for both low and high temperature.
- Particular key for particular padlock.
- No key mixing with any other lock.
- Key mechanism- differ key , alike key , master key available on demand. The new management key technology – 6/10 level management.
- Each lock with specific numbering on body of lock and key.
- Shackle – 25/38/76mm
- Standard shackle, long shackle in Metal/Dielectric shackle available
- Electric current resist from shackle to key, in case of dielectric shackle .
- Main advantage of nylon shackle , in case of emergency, shackle can be cut easily.



KRM CORPORATION

ISO QMS - 9001:2015, ISO EMS 14001:2015, ISO OHSMS 45001:2018
to meet OSHA'S Lockout Tagout Standard 29 CFR, 1910.147&1910.269

KM Safetech Private Limited

QUALITY MANAGEMENT SYSTEM ISO QMS 9001:2015

M: 00 91 9810 291 381, 8800 544 881, T: 00 91 129 - 4021 381

info@krmcorporation.com, info@krmloto.com, krmloto@gmail.com, wadhwarajinder@gmail.com

Postal Add: 615, Sector-15A, Faridabad-121007
Regd. Office: 1H/31A, N.I.T. Faridabad-121001 Haryana - NCR (INDIA)

www.krmloto.com www.krmcorporation.com, www.safetyloto.com
www.lotoappliances.com, www.lockouttagouts.com

003

GSTIN No.: 06AAVPW8746Q1Z6,
PAN No.: AAVPW8746Q
TIN No.: 06821328889,
TAN no.: RTKKO3359G
IEC: 0509006116

M: 00 91 9810 291 381, 8900 544 881



OEM Manufacturer & Global Supplier of
Lockout Tagout & Safety Products

to meet
OSHA'S Lockout Tagout Standard
29 CFR, 1910.147&1910.269



www.lotoappliances.com



GSTIN No.: 06AAECK2831L1Z1
PAN No.: AAECK2831L
TIN No.: 06824000112
CIN No.: U31903HR2011PTC042508
IEC: AAECK2831L

Telefax: 00 91 129 4021 381, 413 1381 (D)

Regd. Office: 1H/31-A, N.I.T, Faridabad-121001 (Haryana) Postal Office: 615, Sector-15-A, Faridabad-121007-Haryana-NCR-INDIA

www.krmcorporation.com | www.lockouttagouts.com | www.krmloto.com | www.locktagindia.com | www.lotoappliances.com

DRAWBACK OF ABS JACKETED METAL PADLOCK:

- KEY NOT RETAINED in this Lock—not recommended to any one for full proof isolation work for safety .
- Possibility for key interchanging is also on higher side.
- That lock was metal body and cover with ABS clipping with spring/ ball cylinder which not hold key in unlock Position.
- Non resistance to electric current, so not recommendable for the high voltage area.
- No specific key arrangement for locking mechanism.

WE ALWAYS RECOMMEND OSHA SAFETY LOCK TAG PADLOCK INSPITE OF ABS JACKETED PADLOCK