



KRM-LOTO
SAFETY PRODUCTS

Lock Tag!! safe loto
to meet OSHA's Lockout Tagout
Standard 29 CFR, 1910.147 & 1910.269

CE
Certified

Manufacturer & Global Supplier of
Lockout \ Tagout & Safety Products

KRM CORPORATION
ISO QMS - 9001:2015, ISO EMS 14001:2015, ISO OHSMS 45001:2018
KRM Safetech Private Limited
QUALITY MANAGEMENT SYSTEM ISO QMS 9001:2015

KRM LOTO CIRCUIT BREAKER LOCKOUT



REGD. OFF. :1H/31-A, N.I.T. FARIDABAD, HARYANA-121001,INDIA POSTAL ADD.:615. SECTOR-15-A, FARIDABAD-121007,INDIA.

www.krmloto.com | www.krmcorporation.com | info@krmloto.com | krmloto@gmail.com | info@krmcorporation.com

**KRM LOTO – CIRCUIT BREAKER LOCKOUT- INDEX****Index Page No:-2**

SR.NO	KRM LOTO PART CODE	PRODUCT NAME	WEIGHT (kg)	PAGE NO.
1	KRM-K-UMCBL-RB	KRM LOTO – UNIVERSAL MINI CIRCUIT BREAKER LOCKOUT COMBINATION OF RED & BLACK	0.030	6-7
2	KRM-K-MPUCBL	KRM LOTO MULTI-POLE UNIVERSAL CIRCUIT BREAKER LOCKOUT	0.040	8-9
3	KRM-K-CBL-3	KRM LOTO – CIRCUIT BREAKER LOCKOUT – ONE POLE/SINGLE POLE	0.030	10-11
4	KRM-K-DMCBL	KRM LOTO – MULTI FUNCTION CIRCUIT BREAKER LOCKOUT	0.020	12-13
5	KRM-K-UCBL-R-P-1	KRM LOTO – UNIVERSAL CIRCUIT BREAKER LOCKOUT WITH NORMAL SCREW	0.018	14-15
6	KRM-K-UCBL-R-N-1	KRM LOTO – UNIVERSAL CIRCUIT BREAKER LOCKOUT WITH NOSE AND NORMAL SCREW	0.018	16-17
7	KRM-K-UCBL-R-P-SS	KRM LOTO – UNIVERSAL CIRCUIT BREAKER LOCKOUT WITH SPECIAL FOLDABLE SCREW	0.023	18-19
8	KRM-K-UCBL-R-N-SS	KRM LOTO – UNIVERSAL CIRCUIT BREAKER LOCKOUT WITH NOSE AT BASE – SPECIAL FOLDABLE SCREW	0.023	20-21
9	KRM-K-MCBL-Y1	KRM LOTO – MINI CIRCUIT BREAKER LOCKOUT WITH NORMAL SCREW - YELLOW	0.08	22-23

OEM Manufacturer & Global Supplier of
Lockout Tagout & Safety Productsto meet
OSHA'S Lockout Tagout Standard
29 CFR, 1910.147&1910.269

www.lotoappliances.com



Regd. Office: 1H/31-A, N.I.T, Faridabad-121001 (Haryana) Postal Office: 615, Sector-15-A, Faridabad-121007-Haryana-NCR-INDIA

www.krmcorporation.com | www.lockouttagouts.com | www.krmloto.com | www.locktagindia.com | www.lotoappliances.com

KRM LOTO – CIRCUIT BREAKER LOCKOUT- INDEX

Index Page No:-5

SR.NO	KRM LOTO PART CODE	PRODUCT NAME	WEIGHT (kg)	TECHNICAL PAGE NO.
30	KRM-K-CBL-1	KRM LOTO – CIRCUIT BREAKER LOCKOUT	0.060	64-65
31	KRM-K-CBL-2	KRM LOTO – CIRCUIT BREAKER LOCKOUT	0.050	66-67
32	KRM-K-CBL-4	KRM LOTO – CIRCUIT BREAKER LOCKOUT – MULTI POLE	0.090	68-69
33	KRM-K-MTLD	KRM LOTO – MCB TOGGLE LOTO DEVICE	0.012	70-71
34	KRM-K-WSLD-1	KRM LOTO – WALL SWITCH LOCKOUT	0.020	72-73
35	KRM-K-WSLD-2	KRM LOTO – WALL SWITCH LOCKOUT	0.020	72-73



OEM Manufacturer & Global Supplier of
Lockout Tagout & Safety Products

to meet
OSHA'S Lockout Tagout Standard
29 CFR, 1910.147&1910.269



www.lootoappliances.com



UNIVERSAL MINI CIRCUIT BREAKER LOCKOUT COMBINATION OF RED & BLACK



- **Material** – Made of ABS
- **Application** – Used to lockout most kind of miniature circuit breaker
- Locks out Circuit Breaker with simple thumb turn up the screw to fix the device
- Easy to handle and suitable for indoor and outdoor applications
- **Dimension** – Height – 52mm Width – 32mm Depth – 18mm Hole Dia – 7.5mm
- **Color** – Red & Black
- It is suitable for 227V & above Circuit breakers.
- Can also provide other colors on requirement on more than 3000 pieces



KRM-K-UMCBL-RB



STEP - 1 : Open the red lock cover handle.



STEP - 2 : Fix the product on circuit breaker, rotate the black button screw clockwise to tighten the lockout.



STEP - 3 : Close the red lock cover.



STEP - 4 : Place the tag and padlock on product slot to lock the circuit breaker.

MODELS	HEIGHT	WIDTH	DEPTH	HOLE DIA	WEIGHT
KRM-K-UMCBL-RB	52mm	32mm	18mm	7.5mm	20gm



OEM Manufacturer & Global Supplier of
Lockout Tagout & Safety Products

to meet
OSHA'S Lockout Tagout Standard
29 CFR, 1910.147&1910.269



www.lotoappliances.com

Email: info@krmloto.com, info@krmcorporation.com, krmloto@gmail.com

Regd. Office: 1H/31-A, N.I.T, Faridabad-121001 (Haryana) Postal Office: 615, Sector-15-A, Faridabad-121007-Haryana-NCR-INDIA



MULTI-POLE UNIVERSAL CIRCUIT BREAKER LOCKOUT

CE Certified



- Multi-pole universal circuit breaker lockouts are made of ABS & nylo with standard steel bolt & are compatible with most two / three pole breakers with a tie-bar.
- Tighten the top screw to clamp the breaker lockout over the tie bar,
- Max. 2 Padlocks are Inserted with ≥ 7.5 mm Padlock Shackle Dia
- Insert/ put the lock to prevent the clamp from being loosened
- This lockout device isolates and secure specific circuit breaker switches to protect employees/workers against electrical accidents during maintenance / shutdown
- Proper lockout on equipment's always save the life of human beings who work on equipment's
- Weight – 30 gm



KRM-K-MPUCBL

A	B	C	D	E	F
58mm	66mm	8.7mm	19mm	32mm	7.5mm



OEM Manufacturer & Global Supplier of
 Lockout Tagout & Safety Products

to meet
 OSHA'S Lockout Tagout Standard
 29 CFR, 1910.147&1910.269



KRM LOTO – CIRCUIT BREAKER LOCKOUT – ONE POLE/SINGLE POLE

- **Material** – Made of ABS
- Durable and are quick and easy to apply.
- Without a hole in the toggle lockout can fit on the circuit breaker toggles up to 12.5 mm wide.
- **Color** – Standard color red or can make as per the quantity required quantity
- Suitable for single pole type MCB
- Used for Circuit Breaker 120V/270V
- **Weight** – 10gm



KRM-K-CBL-3



A	B	C	D	E	F	G
51mm	39mm	30mm	19mm	13mm	9mm	10mm



OEM Manufacturer & Global Supplier of
Lockout Tagout & Safety Products

to meet
OSHA'S Lockout Tagout Standard
29 CFR, 1910.147&1910.269



www.lotoappliances.com



Regd. Office:1H/31-A, N.I.T, Faridabad-121001 (Haryana) Postal Office:615, Sector-15-A, Faridabad-121007-Haryana-NCR-INDIA

www.krmcorporation.com | www.lockouttagouts.com | www.krmloto.com | www.locktagindia.com | www.lotoappliances.com

LOCKOUT/TAGOUT



CIRCUIT BREAKER LOCKOUT – SINGLE POLE

CE Certified



KRM-K-CBL-3

- Material – Made of ABS
- Durable and are quick and easy to apply.
- Without a hole in the toggle lockout can fit on the circuit breaker toggles up to 12.5 mm wide.
- Color – Standard color red or can make as per the quantity required quantity
- Suitable for single pole type MCB
- Used for Circuit Breaker 120V/270V
- Weight – 10gm



A	B	C	D	E	F	G
51mm	39mm	30mm	19mm	13mm	9mm	10mm

KRM CORPORATION

ISO 9001:2015, ISO 14001:2015, ISO 45001:2018
to meet OSHA'S Lockout Tagout Standard 29 CFR, 1910.147&1910.269

KRM Safetech Private Limited

QUALITY MANAGEMENT SYSTEM ISO 9001:2015

M: 00 91 9810 291 381, 8800 544 881, T: 00 91 129 - 4021 381

info@krmcorporation.com, info@krmloto.com, krmloto@gmail.com, wadhwarajinder@gmail.com

Postal Add: 615, Sector-15A, Faridabad-121007 Haryana - NCR (INDIA)
Regd. Office: 1H/31A, N.I.T. Faridabad-121001

www.krmloto.com www.krmcorporation.com, www.safetyloto.com
www.lotoappliances.com, www.lockouttagouts.com



OEM Manufacturer & Global Supplier of
 Lockout Tagout & Safety Products

to meet
 OSHA'S Lockout Tagout Standard
 29 CFR, 1910.147&1910.269



KRM LOTO – MULTI FUNCTION CIRCUIT BREAKER LOCKOUT

- Circuit Breaker Lockout is a versatile device fits on wide range of single, double, triple and four pole of electrical circuit breaker can be accommodates up to one lock and with the help of hasp lockout device can be used for group isolation.
- **Material** - High Quality ABS.
- Designed to lock most of the MCB's and main switches, ideal to be used in residential and industrial purposes.
- Two different sizes of sides are provided so that thick and thin both levers of the MCB's can be fitted into it known as Multi function Circuit Breaker lockout.
- Installation Method - With the help of screw driver loosen the screw and fit the lever of the MCB according to the thickness of the lever then tighten the screw and then fit the lever in it and put the padlock. Also can provide proper tagging for the identification. On hole for the locking purpose.
- Can be used with safety lockout hasp having multiple holes.
- **Weight** - 20 gm.
- **Color** - Standard color Red or can make as per volume.



KRM-K-DMCBL



MODELS	A	B	C	D	E	F	WEIGHT
KRM-K-DMCBL	58mm	45mm	12mm	8mm	37mm	30mm	20 gm



OEM Manufacturer & Global Supplier of
Lockout Tagout & Safety Products

to meet
OSHA'S Lockout Tagout Standard
29 CFR, 1910.147&1910.269



www.lotoappliances.com



Regd. Office:1H/31-A, N.I.T, Faridabad-121001 (Haryana) Postal Office:615, Sector-15-A, Faridabad-121007-Haryana-NCR-INDIA

www.krmcorporation.com | www.lockouttagouts.com | www.krmloto.com | www.locktagindia.com | www.lotoappliances.com

LOCKOUT/TAGOUT



CE
Certified

MULTIFUNCTIONAL CIRCUIT BREAKER LOCKOUT

Circuit Breaker Lockout is a versatile device fits on wide range of single, double, triple and four pole of electrical circuit breaker can be accommodates up to one lock and with the help of hasp lockout device can be used for group isolation.

- **Material** - High Quality ABS.
- Designed to lock most of the MCB's and main switches, ideal to be used in residential and industrial purposes.
- Two different sizes of sides are provided so that thick and thin both levers of the MCB's can be fitted into it known as Multi function Circuit Breaker lockout.
- **Installation Method** - With the help of screw driver loosen the screw and fit the lever of the MCB according to the thickness of the lever then tighten the screw and then fit the lever in it and put the padlock. Also can provide proper tagging for the identification. On hole for the locking purpose.
- Can be used with safety lockout hasp having multiple holes.
- **Weight** - 20 gm.
- **Color** - Standard color Red or can make as per volume.



1 Hole for locking arrangement

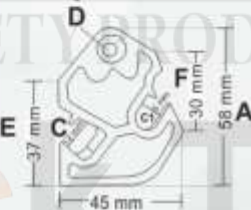

KRM-K-DMCBL

MODELS	A	B	C	D	E	F	WEIGHT
KRM-K-DMCBL	58mm	45mm	12mm	8mm	37mm	30mm	20gm



OEM Manufacturer & Global Supplier of
Lockout Tagout & Safety Products

to meet
OSHA'S Lockout Tagout Standard
29 CFR, 1910.147&1910.269



www.lotoappliances.com



UNIVERSAL CIRCUIT BREAKER LOCKOUT

CE Certified

Universal circuit Breaker lockout is a versatile device fits on wide range of single, double, triple and four pole of electrical circuit breaker can be accommodates up to one lock and with the help of hasp lockout device can be used for group isolation.

- **Material** – High quality ABS with metallic nut
- KRM Universal Circuit Breaker Lockouts will lockout most type of breaker's lever. One size fits in all type of circuit breakers having nose Or without nose for better gripping which is UV resistant and suitable for single, double, tripe and four pole circuit breaker can be locked with single padlock and lockout hasp group locking purpose.
- This is Basically providing a complete solution of circuit breaker safety, in which each product is different from other one includes with nose without nose, normal screw, foldable screw
Specialty of this lockout is that folding screw is there so that no extra tool required for any assistance.
- **Dimension** – height 56 mm, width 26 mm, thickness 19 mm, outer Thickness at locking end 11 mm, locking Hole diameter 9 mm, average Center internal Grip 13.5 mm
- **Color** – Red Or any color make as per the required quantity.



KRM-K-UCBL-R-P1 KRM-K-UCBL-R-N1

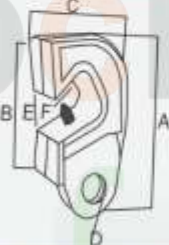

KRM-K-UCBL-R-PSS KRM-K-UCBL-R-N-SS

MODELS	A	B	C	D	E	F	WEIGHT
KRM-K-UCBL-R-P1	56mm	40mm	26mm	9mm	11mm	19mm	18mm
KRM-K-UCBL-R-P-SS	56mm	40mm	26mm	9mm	11mm	19mm	23mm
KRM-K-UCBL-R-N1	56mm	40mm	26mm	9mm	11mm	19mm	18mm
KRM-K-UCBL-R-N-SS	56mm	40mm	26mm	9mm	11mm	19mm	23mm

KRM CORPORATION

ISO 9001:2015, ISO 14001:2015, ISO 45001:2018
to meet OSHA's Lockout Tagout Standard 29 CFR, 1910.147&1910.269

KM Safetech Private Limited

QUALITY MANAGEMENT SYSTEM ISO 9001:2015

M: 00 91 9810 291 381, 8800 544 881, T: 00 91 129 - 4021 381

info@krmcorporation.com, info@krmloto.com, krmloto@gmail.com, wadhwarajinder@gmail.com

Postal Add: 615, Sector-15A, Faridabad-121007 Haryana · NCR (INDIA)
Regd. Office: 1H/31A, N.I.T, Faridabad-121001

www.krmloto.com www.krmcorporation.com, www.safetyloto.com
www.lotoappliances.com, www.lockouttagouts.com





KRM LOTO – UNIVERSAL CIRCUIT BREAKER LOCKOUT WITH NOSE AND NORMAL SCREW

- Universal circuit Breaker lockout is a versatile device fits on wide range of single, double, triple and four pole of electrical circuit breaker can be accommodates up to one lock and with the help of hasp lockout device can be used for group isolation.
- **Material** – High quality ABS KRM Universal Circuit Breaker Lockouts will lockout most type of breaker's lever. One size fits in all type of circuit breakers having nose Or without nose for better gripping which is UV resistant and suitable for single, double, tripe and four pole circuit breaker can be locked with single padlock and lockout hasp.
- **Size** – length 56 mm, width 26 mm, thickness 19 mm, outer Thickness at locking end 11 mm, locking Hole diameter 9 mm, average Centre internal Grip 13.5 mm
- **Weight** –18 gm
- **Color** – Red, Yellow, Green and Blue Or any color make as per the required quantity.



KRM-K-UCBL-R-N-1

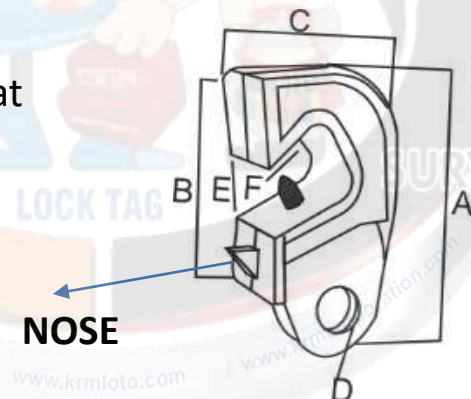

MODELS	A	B	C	D	E	F
KRM-K-UCBL-R-N-1	56 mm	40 mm	26 mm	9 mm	11 mm	19 mm

OEM Manufacturer & Global Supplier of
Lockout Tagout & Safety Products

to meet
OSHA'S Lockout Tagout Standard
29 CFR, 1910.147&1910.269



www.lotoappliances.com



Regd. Office:1H/31-A, N.I.T, Faridabad-121001 (Haryana) Postal Office:615, Sector-15-A, Faridabad-121007-Haryana-NCR-INDIA

www.krmcorporation.com | www.lockouttagouts.com | www.krmloto.com | www.locktagindia.com | www.lotoappliances.com



UNIVERSAL CIRCUIT BREAKER LOCKOUT

CE Certified

Universal circuit Breaker lockout is a versatile device fits on wide range of single, double, triple and four pole of electrical circuit breaker can be accommodates up to one lock and with the help of hasp lockout device can be used for group isolation.

- **Material** – High quality ABS with metallic nut
- KRM Universal Circuit Breaker Lockouts will lockout most type of breaker's lever. One size fits in all type of circuit breakers having nose Or without nose for better gripping which is UV resistant and suitable for single, double, tripe and four pole circuit breaker can be locked with single padlock and lockout hasp group locking purpose.
- This is Basically providing a complete solution of circuit breaker safety, in which each product is different from other one includes with nose without nose, normal screw, foldable screw
Specialty of this lockout is that folding screw is there so that no extra tool required for any assistance.
- **Dimension** – height 56 mm, width 26 mm, thickness 19 mm, outer Thickness at locking end 11 mm, locking Hole diameter 9 mm, average Center internal Grip 13.5 mm
- **Color** – Red Or any color make as per the required quantity.



KRM-K-UCBL-R-P1 KRM-K-UCBL-R-N1

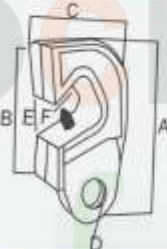

KRM-K-UCBL-R-PSS KRM-K-UCBL-R-N-SS

MODELS	A	B	C	D	E	F	WEIGHT
KRM-K-UCBL-R-P1	56mm	40mm	26mm	9mm	11mm	19mm	18mm
KRM-K-UCBL-R-P-SS	56mm	40mm	26mm	9mm	11mm	19mm	23mm
KRM-K-UCBL-R-N1	56mm	40mm	26mm	9mm	11mm	19mm	18mm
KRM-K-UCBL-R-N-SS	56mm	40mm	26mm	9mm	11mm	19mm	23mm

KRM CORPORATION

ISO QMS - 9001:2015, ISO EMS - 14001:2015, ISO OHSMS - 45001:2018
to meet OSHA's Lockout Tagout Standard 29 CFR, 1910.147 & 1910.269

KM Safetech Private Limited

QUALITY MANAGEMENT SYSTEM ISO QMS 9001:2015

M: 00 91 9810 291 381, 8800 544 881, T: 00 91 129 - 4021 381

info@krmcorporation.com, info@krmloto.com, krmloto@gmail.com, wadhwarajinder@gmail.com

Postal Add: 615, Sector-15A, Faridabad-121007 Haryana · NCR (INDIA)
Regd. Office: 1H/31A, N.I.T, Faridabad-121001

www.krmloto.com www.krmcorporation.com, www.safetyloto.com
www.lotoappliances.com, www.lockouttagouts.com





OEM Manufacturer & Global Supplier of
Lockout Tagout & Safety Products

to meet
OSHA'S Lockout Tagout Standard
29 CFR, 1910.147&1910.269



KRM LOTO – UNIVERSAL CIRCUIT BREAKER LOCKOUT WITH SPECIAL FOLDABLE SCREW

- Universal circuit Breaker lockout is a versatile device fits on wide range of single, double, triple and four pole of electrical circuit breaker can be accommodates up to one lock and with the help of hasp lockout device can be used for group isolation.
- **Material** – High quality ABS with metallic nut
- KRM Universal Circuit Breaker Lockouts will lockout most type of breaker's lever. One size fits in all type of circuit breakers having nose Or without nose for better gripping which is UV resistant and suitable for single, double, triple and four pole circuit breaker can be locked with single padlock and lockout hasp.
- Specialty of this lockout is that folding screw is there so that no extra tool required for any assistance.
- **Size** – length 56 mm, width 26 mm, thickness 19 mm, outer Thickness at locking end 11 mm, locking Hole diameter 9 mm, average Centre internal Grip 13.5 mm, Average center internal Grip 13.5 mm
- **Weight** – 23 gm
- **Color** – Red, Yellow, Green and Blue Or any color make as per the required quantity.



KRM-K-UCBL-R-P-SS

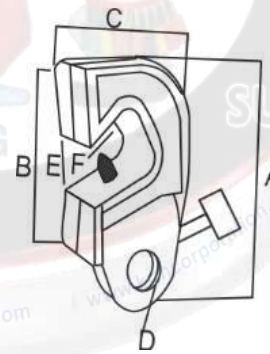

MODELS	A	B	C	D	E	F
KRM-K-UCBL-R-P-SS	56 mm	40 mm	26 mm	9 mm	11 mm	19 mm



OEM Manufacturer & Global Supplier of
Lockout Tagout & Safety Products

to meet
OSHA'S Lockout Tagout Standard
29 CFR, 1910.147&1910.269



www.lotoappliances.com



UNIVERSAL CIRCUIT BREAKER LOCKOUT

CE Certified



KRM-K-UCBL-R-P1 KRM-K-UCBL-R-N1

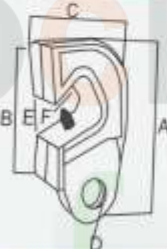

KRM-K-UCBL-R-PSS KRM-K-UCBL-R-N-SS

Universal circuit Breaker lockout is a versatile device fits on wide range of single, double, triple and four pole of electrical circuit breaker can be accommodates up to one lock and with the help of hasp lockout device can be used for group isolation.

- **Material** – High quality ABS with metallic nut
- KRM Universal Circuit Breaker Lockouts will lockout most type of breaker's lever. One size fits in all type of circuit breakers having nose Or without nose for better gripping which is UV resistant and suitable for single, double, tripe and four pole circuit breaker can be locked with single padlock and lockout hasp group locking purpose.
- This is Basically providing a complete solution of circuit breaker safety, in which each product is different from other one includes with nose without nose, normal screw, foldable screw
Specialty of this lockout is that folding screw is there so that no extra tool required for any assistance.
- **Dimension** – height 56 mm, width 26 mm, thickness 19 mm, outer Thickness at locking end 11 mm, locking Hole diameter 9 mm, average Center internal Grip 13.5 mm
- **Color** – Red Or any color make as per the required quantity.

MODELS	A	B	C	D	E	F	WEIGHT
KRM-K-UCBL-R-P1	56mm	40mm	26mm	9mm	11mm	19mm	18mm
KRM-K-UCBL-R-P-SS	56mm	40mm	26mm	9mm	11mm	19mm	23mm
KRM-K-UCBL-R-N1	56mm	40mm	26mm	9mm	11mm	19mm	18mm
KRM-K-UCBL-R-N-SS	56mm	40mm	26mm	9mm	11mm	19mm	23mm

KRM CORPORATION

ISO 9001:2015, ISO 14001:2015, ISO 45001:2018, ISO 9001:2015
to meet OSHA's Lockout Tagout Standard 29 CFR, 1910.147&1910.269

KM Safetech Private Limited

QUALITY MANAGEMENT SYSTEM ISO 9001:2015

M: 00 91 9810 291 381, 8800 544 881, T: 00 91 129 - 4021 381

info@krmcorporation.com, info@krmloto.com, krmloto@gmail.com, wadhwarajinder@gmail.com

Postal Add: 615, Sector-15A, Faridabad-121007 Haryana · NCR (INDIA)
Regd. Office: 1H/31A, N.I.T, Faridabad-121001

www.krmloto.com www.krmcorporation.com, www.safetyloto.com
www.lotoappliances.com, www.lockouttagouts.com





OEM Manufacturer & Global Supplier of
 Lockout Tagout & Safety Products

to meet
 OSHA'S Lockout Tagout Standard
 29 CFR, 1910.147&1910.269

www.lotoappliances.com



KRM LOTO – UNIVERSAL CIRCUIT BREAKER LOCKOUT WITH NOSE AT BASE – SPECIAL FOLDABLE SCREW

- Universal circuit Breaker lockout is a versatile device fits on wide range of single, double, triple and four pole of electrical circuit breaker can be accommodates up to one lock and with the help of hasp lockout device can be used for group isolation.
- **Material** – High quality ABS with metallic nut KRM Universal Circuit Breaker Lockouts will lockout most type of breaker's lever.
- One size fits in all type of circuit breakers having nose Or without nose for better gripping which is UV resistant and suitable for single, double, tripe and four pole circuit breaker can be locked with single padlock and lockout hasp.
- Specialty of this lockout is that folding screw is there so that no extra tool required for any assistance.
- **Size** – length 56 mm, width 26 mm, thickness 19 mm, outer Thickness at locking end 11 mm, locking Hole diameter 9 mm, average Centre internal Grip 13.5 m, Average center internal Grip 13.5 mm
- **Weight** – 23 gm
- **Color** – Red, Yellow, Green and Blue Or any color make as per the required quantity.



KRM-K-UCBL-R-N-SS

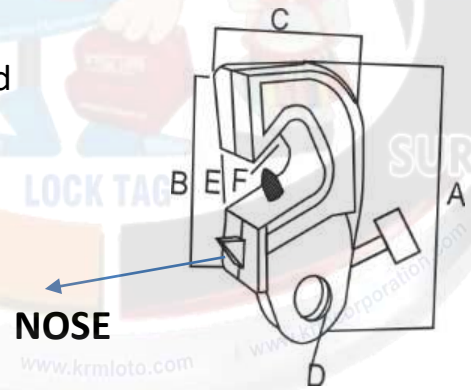

MODELS	A	B	C	D	E	F
KRM-K-UCBL-R-P-SS	56 mm	40 mm	26 mm	9 mm	11 mm	19 mm

OEM Manufacturer & Global Supplier of
Lockout Tagout & Safety Products

to meet
OSHA'S Lockout Tagout Standard
29 CFR, 1910.147&1910.269



www.lotoappliances.com



Regd. Office: 1H/31-A, N.I.T, Faridabad-121001 (Haryana) | Postal Office: 615, Sector-15-A, Faridabad-121007-Haryana-NCR-INDIA

www.krmcorporation.com | www.lockouttagouts.com | www.krmloto.com | www.locktagindia.com | www.lotoappliances.com



UNIVERSAL CIRCUIT BREAKER LOCKOUT

CE Certified

Universal circuit breaker lockout is a versatile device fits on wide range of single, double, triple and four pole of electrical circuit breaker can be accommodates up to one lock and with the help of hasp lockout device can be used for group isolation.

- **Material** – High quality ABS with metallic nut
- KRM Universal Circuit Breaker Lockouts will lockout most type of breaker's lever. One size fits in all type of circuit breakers having nose Or without nose for better gripping which is UV resistant and suitable for single, double, tripe and four pole circuit breaker can be locked with single padlock and lockout hasp group locking purpose.
- This is Basically providing a complete solution of circuit breaker safety, in which each product is different from other one includes with nose without nose, normal screw, foldable screw
Specialty of this lockout is that folding screw is there so that no extra tool required for any assistance.
- **Dimension** – height 56 mm, width 26 mm, thickness 19 mm, outer Thickness at locking end 11 mm, locking Hole diameter 9 mm, average Center internal Grip 13.5 mm
- **Color** – Red Or any color make as per the required quantity.



KRM-K-UCBL-R-P1 KRM-K-UCBL-R-N1

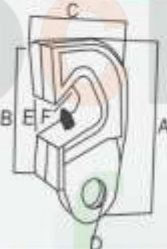

KRM-K-UCBL-R-PSS KRM-K-UCBL-R-N-SS

MODELS	A	B	C	D	E	F	WEIGHT
KRM-K-UCBL-R-P1	56mm	40mm	26mm	9mm	11mm	19mm	18mm
KRM-K-UCBL-R-P-SS	56mm	40mm	26mm	9mm	11mm	19mm	23mm
KRM-K-UCBL-R-N1	56mm	40mm	26mm	9mm	11mm	19mm	18mm
KRM-K-UCBL-R-N-SS	56mm	40mm	26mm	9mm	11mm	19mm	23mm

KRM CORPORATION

ISO QMS - 9001:2015, ISO EMS - 14001:2015, ISO OHSMS - 45001:2018
to meet OSHA's Lockout Tagout Standard 29 CFR, 1910.147 & 1910.269

KM Safetech Private Limited

QUALITY MANAGEMENT SYSTEM ISO QMS 9001:2015

M: 00 91 9810 291 381, 8800 544 881, T: 00 91 129 - 4021 381

info@krmcorporation.com, info@krmloto.com, krmloto@gmail.com, wadhwarajinder@gmail.com

Postal Add: 615, Sector-15A, Faridabad-121007 Haryana · NCR (INDIA)
Regd. Office: 1H/31A, N.I.T, Faridabad-121001

www.krmloto.com | www.krmcorporation.com, www.safetyloto.com
www.lotoappliances.com, www.lockouttagouts.com





OEM Manufacturer & Global Supplier of
Lockout Tagout & Safety Products

to meet
OSHA'S Lockout Tagout Standard
29 CFR, 1910.147&1910.269



www.lockoutappliances.com



KRM LOTO – MINI CIRCUIT BREAKER LOCKOUT WITH NORMAL SCREW - YELLOW

LOCKOUT/TAGOUT

- Mini Circuit Breaker Lockout is versatile device fits on wide range of single, double, triple and four pole of electrical circuit can be accommodates up to one lock and with the help of hasp lockout device can be used for group isolation.
- **Material** - High Quality ABS with metallic nut.
- KRM Circuit Breaker Lockout with plain and folding screw type that is UV resistant. It fits on wide range of switches that is of 0.30" to 0.60" height suitable for single, double, triple and four pole.
- **Dimension** – KRM-K-MCBL-Y1 Center to center length 49 mm, width at large curve end 30 mm, width at lower 24 mm, thickness 10 mm, internal hole diameter 9 mm, average center internal grip 8mm.
- **Weight** - 10gm
- **Color** - Yellow, Red or any color as per the quantity required.



KRM-K-MCBL-Y1



MODELS	A	B	C	D	E	F	WEIGHT
KRM-K-MCBL-Y1	49 mm	30 mm	24 mm	9 mm	12 mm	10 mm	10 gm



MINI CIRCUIT BREAKER LOCKOUT



KRM-K-MCBL-Y1



KRM-K-MCBL-Y-NS



KRM-K-MCBL-Y-SS

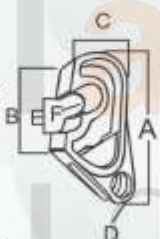

- Mini Circuit Breaker Lockout is versatile device fits on wide range of single, double, triple and four pole of electrical circuit can be accommodates up to one lock and with the help of hasp lockout device can be used for group isolation.
- **Material** - High Quality ABS with metallic nut.
- KRM Circuit Breaker Lockout with plain and folding screw type that is UV resistant. It fits on wide range of switches that is of 0.30" to 0.60" height suitable for single, double, triple and four pole.
- **Dimension** - **KRM-K-MCBL-Y1** Center to center length 49 mm, width at large curve end 30 mm, width at lower 24 mm, thickness 10 mm, internal hole diameter 9 mm, average center internal grip 8mm. **KRM-K-MCBL-Y-NS, KRM-K-MCBL-Y-SS** Center to center length 58 mm, width at large curve end 35 mm, width at lower 24.5 mm, thickness 19 mm, internal hole diameter 10 mm, average center internal grip 8mm.
- Specialty of this lockout is that folding screw is there so that no extra tool required for any assistance.
- **Weight** - 10/14 gm with simple screw 22gm with foldable screw
- **Color** - Yellow or any color as per the quantity required.

MODELS	A	B	C	D	E	F	WEIGHT G
KRM-K-MCBL-Y1	49mm	30mm	24mm	9mm	12mm	10mm	10gm
KRM-K-MCBL-Y-NS	58mm	35mm	24.5mm	10mm	15mm	19mm	14gm
KRM-K-MCBL-Y-SS	58mm	35mm	24.5mm	10mm	15mm	19mm	22gm



KRM LOTO – MINI CIRCUIT BREAKER LOCKOUT WITH NORMAL SCREW- YELLOW

- Mini Circuit Breaker Lockout is versatile device fits on wide range of single, double, triple and four pole of electrical circuit can be accommodates up to one lock and with the help of hasp lockout device can be used for group isolation.
- Material - High Quality ABS with metallic nut.
- KRM Circuit Breaker Lockout with plain and folding screw type that is UV resistant. It fits on wide range of switches that is of 0.30" to 0.60" height suitable for single , double, triple and four pole.
- **Dimension** – KRM-K-MCBL-Y-NS Center to center length 58 mm, width at large curve end 35 mm, width at lower 24.5 mm, thickness 19 mm, internal hole diameter 10 mm, average center internal grip 8mm.
- **Weight** - 14gm
- **Color** - Yellow, Red or any color as per the quantity required.



KRM-K-MCBL-Y-NS



MODELS	A	B	C	D	E	F	WEIGHT
KRM-K-MCBL-Y-NS	58 mm	35 mm	24.5 mm	10 mm	15 mm	19 mm	14 gm



OEM Manufacturer & Global Supplier of
Lockout Tagout & Safety Products

to meet
OSHA'S Lockout Tagout Standard
29 CFR, 1910.147&1910.269



www.lockoutappliances.com



Regd. Office: 1H/31-A, N.I.T, Faridabad-121001 (Haryana) Postal Office: 615, Sector-15-A, Faridabad-121007-Haryana-NCR-INDIA

www.krmcorporation.com | www.lockouttagouts.com | www.krmloto.com | www.locktagindia.com | www.lotoappliances.com

MINI CIRCUIT BREAKER LOCKOUT



KRM-K-MCBL-Y1



KRM-K-MCBL-Y-NS



KRM-K-MCBL-Y-SS



- Mini Circuit Breaker Lockout is versatile device fits on wide range of single, double, triple and four pole of electrical circuit can be accommodates up to one lock and with the help of hasp lockout device can be used for group isolation.
- **Material** - High Quality ABS with metallic nut.
- KRM Circuit Breaker Lockout with plain and folding screw type that is UV resistant. It fits on wide range of switches that is of 0.30" to 0.60" height suitable for single, double, triple and four pole.
- **Dimension** - **KRM-K-MCBL-Y1** Center to center length 49 mm, width at large curve end 30 mm, width at lower 24 mm, thickness 10 mm, internal hole diameter 9 mm, average center internal grip 8mm. **KRM-K-MCBL-Y-NS, KRM-K-MCBL-Y-SS** Center to center length 58 mm, width at large curve end 35 mm, width at lower 24.5 mm, thickness 19 mm, internal hole diameter 10 mm, average center internal grip 8mm.
- Specialty of this lockout is that folding screw is there so that no extra tool required for any assistance.
- **Weight** - 10/14 gm with simple screw 22gm with foldable screw
- **Color** - Yellow or any color as per the quantity required.

MODELS	A	B	C	D	E	F	WEIGHT G
KRM-K-MCBL-Y1	49mm	30mm	24mm	9mm	12mm	10mm	10gm
KRM-K-MCBL-Y-NS	58mm	35mm	24.5mm	10mm	15mm	19mm	14gm
KRM-K-MCBL-Y-SS	58mm	35mm	24.5mm	10mm	15mm	19mm	22gm



KRM LOTO – MINI CIRCUIT BREAKER LOCKOUT WITH SPECIAL FOLDABLE SCREW- YELLOW

- Mini Circuit Breaker Lockout is versatile device fits on wide range of single, double, triple and four pole of electrical circuit can be accommodates up to one lock and with the help of hasp lockout device can be used for group isolation.
- Material - High Quality ABS with metallic nut.
- KRM Circuit Breaker Lockout with plain and folding screw type that is UV resistant. It fits on wide range of switches that is of 0.30" to 0.60" height suitable for single , double, triple and four pole.
- **Dimension** – KRM-K-MCBL-Y-SS Center to center length 58 mm, width at large curve end 35 mm, width at lower 24.5 mm, thickness 19 mm, internal hole diameter 10 mm, average center internal grip 8mm.
- Specialty of this lockout is that folding screw is there so that no extra tool required for any assistance.
- **Weight** - 22gm
- **Color** - Yellow, Red or any color as per the quantity required



KRM-K-MCBL-Y -SS

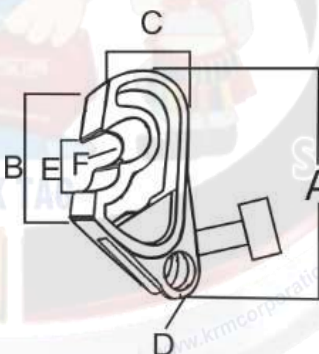

MODELS	A	B	C	D	E	F	WEIGHT
KRM-K-MCBL-Y-SS	58 mm	35 mm	24.5 mm	10 mm	15 mm	19 mm	22 gm



OEM Manufacturer & Global Supplier of
Lockout Tagout & Safety Products

to meet
OSHA'S Lockout Tagout Standard
29 CFR, 1910.147&1910.269



www.lockouttagouts.com



Regd. Office: 1H/31-A, N.I.T, Faridabad-121001 (Haryana) Postal Office: 615, Sector-15-A, Faridabad-121007-Haryana-NCR-INDIA

www.krmcorporation.com | www.lockouttagouts.com | www.krmloto.com | www.locktagindia.com | www.lotoappliances.com

MINI CIRCUIT BREAKER LOCKOUT



KRM-K-MCBL-Y1



KRM-K-MCBL-Y-NS



KRM-K-MCBL-Y-SS



- Mini Circuit Breaker Lockout is versatile device fits on wide range of single, double, triple and four pole of electrical circuit can be accommodates up to one lock and with the help of hasp lockout device can be used for group isolation.
- **Material** - High Quality ABS with metallic nut.
- KRM Circuit Breaker Lockout with plain and folding screw type that is UV resistant. It fits on wide range of switches that is of 0.30" to 0.60" height suitable for single, double, triple and four pole.
- **Dimension** - **KRM-K-MCBL-Y1** Center to center length 49 mm, width at large curve end 30 mm, width at lower 24 mm, thickness 10 mm, internal hole diameter 9 mm, average center internal grip 8mm. **KRM-K-MCBL-Y-NS, KRM-K-MCBL-Y-SS** Center to center length 58 mm, width at large curve end 35 mm, width at lower 24.5 mm, thickness 19 mm, internal hole diameter 10 mm, average center internal grip 8mm.
- Specialty of this lockout is that folding screw is there so that no extra tool required for any assistance.
- **Weight** - 10/14 gm with simple screw 22gm with foldable screw
- **Color** - Yellow or any color as per the quantity required.

MODELS	A	B	C	D	E	F	WEIGHT G
KRM-K-MCBL-Y1	49mm	30mm	24mm	9mm	12mm	10mm	10gm
KRM-K-MCBL-Y-NS	58mm	35mm	24.5mm	10mm	15mm	19mm	14gm
KRM-K-MCBL-Y-SS	58mm	35mm	24.5mm	10mm	15mm	19mm	22gm



KRM LOTO – CIRCUIT BREAKER LOCKOUT WITH NORMAL SCREW- BLUE

- **Material** - High Quality ABS with metallic screw.
- KRM Circuit Breaker lockout is available with four options that is with nose, without nose, with foldable screw and normal/plain screw.
- Plain or normal screw type device can be tighten up with the help of screw driver and foldable screw type device that can be installed directly without the help of any extra tool.
- The device is UV Resistant and it is suitable for single, double, triple and four pole also can be fitted on switches of 30" to 90" height.
- **Dimension** - height 49 mm, width 26 mm, thickness 19 mm, outer Thickness at locking end 11 mm, locking Hole diameter 9 mm, average Center internal Grip 13.5 mm
- **Weight** – 22 gm
- **Color** – Blue Or can make as per required quantity.



KRM-K-CBL-B-P-1



MODELS	A	B	C	D	E	F
KRM-K-CBL-B-P-1	49 mm	40 mm	26 mm	9 mm	11 mm	19 mm



OEM Manufacturer & Global Supplier of
Lockout Tagout & Safety Products

to meet
OSHA'S Lockout Tagout Standard
29 CFR, 1910.147&1910.269



www.lockouttagouts.com



Regd. Office: 1H/31-A, N.I.T, Faridabad-121001 (Haryana) Postal Office: 615, Sector-15-A, Faridabad-121007-Haryana-NCR-INDIA

www.krmcorporation.com | www.lockouttagouts.com | www.krmloto.com | www.locktagindia.com | www.lotoappliances.com



CIRCUIT BREAKER LOCKOUT-BLUE

CE Certified

- **Material** - High Quality ABS with metallic screw.
- KRM Circuit Breaker lockout is available with four options that is with nose, without nose, with foldable screw and normal/plain screw.
- Plain or normal screw type device can be tighten up with the help of screw driver and foldable screw type device that can be installed directly without the help of any extra tool.
- The device is UV Resistant and it is suitable for single, double, triple and four pole also can be fitted on switches of 30" to 90" height.
- **Dimension** – KRM-K-CBL-B-NS, KRM-K-CBL-B-SS height 55 mm, width 26 mm, thickness 19 mm, outer Thickness at locking end 11 mm, locking Hole diameter 9 mm, average Center internal Grip 13.5 mm
KRM-K-CBL-B-P-1, KRM-K-CBL-B-N-1 height 49 mm, width 26 mm, thickness 19 mm, outer Thickness at locking end 11 mm, locking Hole diameter 9 mm, average Center internal Grip 13.5 mm
- **Weight** – 35 gm for with foldable screw, 30/22 gm of normal screw type
- **Color** – Blue Or can make as per required quantity.

MODELS	A	B	C	D	E	F	WEIGHT
KRM-K-CBL-B-NS	55mm	40mm	26mm	9mm	11mm	19mm	30gm
KRM-K-CBL-B-SS	55mm	40mm	26mm	9mm	11mm	19mm	35gm
KRM-K-CBL-B-P-1	49mm	40mm	26mm	9mm	11mm	19mm	22gm
KRM-K-CBL-B-N-1	49mm	40mm	26mm	9mm	11mm	19mm	22gm



OEM Manufacturer & Global Supplier of
Lockout Tagout & Safety Products

to meet
OSHA'S Lockout Tagout Standard
29 CFR, 1910.147&1910.269

www.lotoappliances.com



Email: info@krmloto.com, info@krmcorporation.com, krmloto@gmail.com

Regd. Office:1H/31-A, N.I.T, Faridabad-121001 (Haryana) Postal Office:615, Sector-15-A, Faridabad-121007-Haryana-NCR-INDIA



KRM LOTO – CIRCUIT BREAKER LOCKOUT WITH NORMAL SCREW AND NOSE - BLUE

- **Material** - High Quality ABS with metallic screw.
- KRM Circuit Breaker lockout is available with four options that is with nose, without nose, with foldable screw and normal/plain screw.
- Plain or normal screw type device can be tighten up with the help of screw driver and foldable screw type device that can be installed directly without the help of any extra tool.
- The device is UV Resistant and it is suitable for single, double, triple and four pole also can be fitted on switches of 30" to 90" height.
- **Dimension** - height 49 mm, width 26 mm, thickness 19 mm, outer Thickness at locking end 11 mm, locking Hole diameter 9 mm, average Center internal Grip 13.5 mm
- **Weight** – 22 gm
- **Color** – Blue Or can make as per required quantity.



KRM-K-CBL-B-N-1

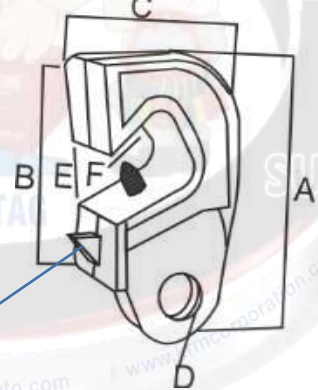

NOSE

MODELS	A	B	C	D	E	F
KRM-K-CBL-B-N-1	49 mm	40 mm	26 mm	9 mm	11 mm	19 mm



OEM Manufacturer & Global Supplier of
Lockout Tagout & Safety Products

to meet
OSHA'S Lockout Tagout Standard
29 CFR, 1910.147&1910.269



www.lockouttagouts.com



CIRCUIT BREAKER LOCKOUT-BLUE

CE Certified

KRM LOTO EXPERT

- **Material** - High Quality ABS with metallic screw.
- KRM Circuit Breaker lockout is available with four options that is with nose, without nose, with foldable screw and normal/plain screw.
- Plain or normal screw type device can be tighten up with the help of screw driver and foldable screw type device that can be installed directly without the help of any extra tool.
- The device is UV Resistant and it is suitable for single, double, triple and four pole also can be fitted on switches of 30" to 90" height.
- **Dimension** – KRM-K-CBL-B-NS, KRM-K-CBL-B-SS height 55 mm, width 26 mm, thickness 19 mm, outer Thickness at locking end 11 mm, locking Hole diameter 9 mm, average Center internal Grip 13.5 mm
KRM-K-CBL-B-P-1, KRM-K-CBL-B-N-1 height 49 mm, width 26 mm, thickness 19 mm, outer Thickness at locking end 11 mm, locking Hole diameter 9 mm, average Center internal Grip 13.5 mm
- **Weight** – 35 gm for with foldable screw, 30/22 gm of normal screw type
- **Color** – Blue Or can make as per required quantity.



KRM-K-CBL-B-NS



KRM-K-CBL-B-P-1

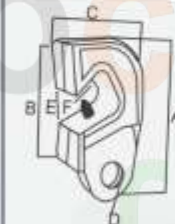

KRM-K-CBL-B-SS



KRM-K-CBL-B-N-1

MODELS	A	B	C	D	E	F	WEIGHT
KRM-K-CBL-B-NS	55mm	40mm	26mm	9mm	11mm	19mm	30gm
KRM-K-CBL-B-SS	55mm	40mm	26mm	9mm	11mm	19mm	35gm
KRM-K-CBL-B-P-1	49mm	40mm	26mm	9mm	11mm	19mm	22gm
KRM-K-CBL-B-N-1	49mm	40mm	26mm	9mm	11mm	19mm	22gm



KRM LOTO – CIRCUIT BREAKER LOCKOUT WITH NORMAL SCREW - BLUE

- **Material** - High Quality ABS with metallic screw.
- KRM Circuit Breaker lockout is available with four options that is with nose, without nose, with foldable screw and normal/plain screw.
- Plain or normal screw type device can be tighten up with the help of screw driver and foldable screw type device that can be installed directly without the help of any extra tool.
- The device is UV Resistant and it is suitable for single, double, triple and four pole also can be fitted on switches of 30" to 90" height.
- **Dimension** – KRM-K-CBL-B-NS height 55 mm, width 26 mm, thickness 19 mm, outer Thickness at locking end 11 mm, locking Hole diameter 9 mm, average Center internal Grip 13.5 mm
- **Weight** – 30 gm
- **Color** – Blue Or can make as per required quantity.



KRM-K-CBL-B-NS



MODELS	A	B	C	D	E	F
KRM-K-CBL-B-NS	55 mm	40 mm	26 mm	9 mm	11 mm	19 mm



OEM Manufacturer & Global Supplier of
Lockout Tagout & Safety Products

to meet
OSHA'S Lockout Tagout Standard
29 CFR, 1910.147&1910.269



www.lotoappliances.com



Regd. Office: 1H/31-A, N.I.T, Faridabad-121001 (Haryana) Postal Office: 615, Sector-15-A, Faridabad-121007-Haryana-NCR-INDIA

www.krmcorporation.com | www.lockouttagouts.com | www.krmloto.com | www.locktagindia.com | www.lotoappliances.com



CIRCUIT BREAKER LOCKOUT-BLUE

CE Certified

- **Material** - High Quality ABS with metallic screw.
- KRM Circuit Breaker lockout is available with four options that is with nose, without nose, with foldable screw and normal/plain screw.
- Plain or normal screw type device can be tighten up with the help of screw driver and foldable screw type device that can be installed directly without the help of any extra tool.
- The device is UV Resistant and it is suitable for single, double, triple and four pole also can be fitted on switches of 30" to 90" height.
- **Dimension** – KRM-K-CBL-B-NS, KRM-K-CBL-B-SS height 55 mm, width 26 mm, thickness 19 mm, outer Thickness at locking end 11 mm, locking Hole diameter 9 mm, average Center internal Grip 13.5 mm
KRM-K-CBL-B-P-1, KRM-K-CBL-B-N-1 height 49 mm, width 26 mm, thickness 19 mm, outer Thickness at locking end 11 mm, locking Hole diameter 9 mm, average Center internal Grip 13.5 mm
- **Weight** – 35 gm for with foldable screw, 30/22 gm of normal screw type
- **Color** – Blue Or can make as per required quantity.

MODELS	A	B	C	D	E	F	WEIGHT
KRM-K-CBL-B-NS	55mm	40mm	26mm	9mm	11mm	19mm	30gm
KRM-K-CBL-B-SS	55mm	40mm	26mm	9mm	11mm	19mm	35gm
KRM-K-CBL-B-P-1	49mm	40mm	26mm	9mm	11mm	19mm	22gm
KRM-K-CBL-B-N-1	49mm	40mm	26mm	9mm	11mm	19mm	22gm



OEM Manufacturer & Global Supplier of
Lockout Tagout & Safety Products

to meet
OSHA'S Lockout Tagout Standard
29 CFR, 1910.147&1910.269



www.lockouttagouts.com



Regd. Office: 1H/31-A, N.I.T, Faridabad-121001 (Haryana) Postal Office: 615, Sector-15-A, Faridabad-121007-Haryana-NCR-INDIA

www.krmcorporation.com | www.lockouttagouts.com | www.krmloto.com | www.locktagindia.com | www.lotoappliances.com



CIRCUIT BREAKER LOCKOUT-BLUE

CE Certified

- **Material** - High Quality ABS with metallic screw.
- KRM Circuit Breaker lockout is available with four options that is with nose, without nose, with foldable screw and normal/plain screw.
- Plain or normal screw type device can be tighten up with the help of screw driver and foldable screw type device that can be installed directly without the help of any extra tool.
- The device is UV Resistant and it is suitable for single, double, triple and four pole also can be fitted on switches of 30" to 90" height.
- **Dimension** – KRM-K-CBL-B-NS, KRM-K-CBL-B-SS height 55 mm, width 26 mm, thickness 19 mm, outer Thickness at locking end 11 mm, locking Hole diameter 9 mm, average Center internal Grip 13.5 mm
KRM-K-CBL-B-P-1, KRM-K-CBL-B-N-1 height 49 mm, width 26 mm, thickness 19 mm, outer Thickness at locking end 11 mm, locking Hole diameter 9 mm, average Center internal Grip 13.5 mm
- **Weight** – 35 gm for with foldable screw, 30/22 gm of normal screw type
- **Color** – Blue Or can make as per required quantity.

MODELS	A	B	C	D	E	F	WEIGHT
KRM-K-CBL-B-NS	55mm	40mm	26mm	9mm	11mm	19mm	30gm
KRM-K-CBL-B-SS	55mm	40mm	26mm	9mm	11mm	19mm	35gm
KRM-K-CBL-B-P-1	49mm	40mm	26mm	9mm	11mm	19mm	22gm
KRM-K-CBL-B-N-1	49mm	40mm	26mm	9mm	11mm	19mm	22gm



OEM Manufacturer & Global Supplier of
 Lockout Tagout & Safety Products

to meet
 OSHA'S Lockout Tagout Standard
 29 CFR, 1910.147&1910.269



www.lotoappliances.com



KRM LOTO – MINI CIRCUIT BREAKER LOCKOUT WITH NORMAL SCREW - GREEN

- For providing protection to different energy sources for group isolation when multiple authorized employees need to lockout the same energy sources at a time to meet OSHA's Lockout Tagout Standard.
- KRM Circuit Breaker Screw - Plain Type.
- Material - ABS. UV resistant. Use - Suitable for single/double/triple pole.
- Dimension - Height - 43 mm, Width - 25 mm, Depth - 15 mm, Internal Hole Dia - 9 mm. Average Center internal grip - 12.5 mm.
- Weight - 10 gm
- Color - Green or any color can make as per required quantity.



KRM-K-MCBL-G-1

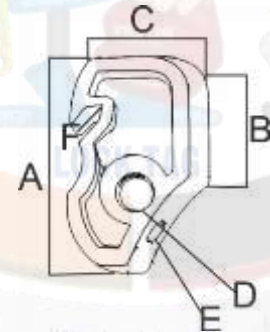

MODEL	A	B	C	D	E	F
KRM-K-MCBL-G-1	43 mm	25 mm	25 mm	9 mm	6 mm	15 mm



OEM Manufacturer & Global Supplier of
Lockout Tagout & Safety Products

to meet
OSHA'S Lockout Tagout Standard
29 CFR, 1910.147&1910.269



www.lotoappliances.com



Regd. Office: 1H/31-A, N.I.T, Faridabad-121001 (Haryana) Postal Office: 615, Sector-15-A, Faridabad-121007-Haryana-NCR-INDIA

www.krmcorporation.com | www.lockouttagouts.com | www.krmloto.com | www.locktagindia.com | www.lotoappliances.com



KRM LOTO
SAFETY PRODUCTS
safe loto

CE
Certified

MINI CIRCUIT BREAKER LOCKOUT WITH NORMAL SCREW - GREEN

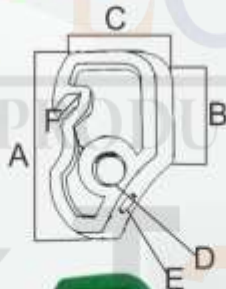

KRM-K-MCBL-G 1

- For providing protection to different energy sources for group isolation when multiple authorized employees need to lockout the same energy sources at a time to meet OSHA's Lockout Tagout Standard.
- KRM Circuit Breaker Screw - Plain Type.
- **Material** - ABS. UV resistant. Use - Suitable for single/double/triple pole.
- **Dimension** - Height - 43 mm, Width - 25 mm, Depth - 15 mm, Internal Hole Dia - 9 mm. Average Center internal grip - 12.5 mm.
- **Weight** - 10 gms
- **Color** - Green or any color can make as per required quantity.

MODELS	A	B	C	D	E	F
KRM-K-MCBL-G 1	43mm	25mm	25mm	9mm	6mm	12.5mm

KRM CORPORATION

ISO 9001:2015, ISO 14001:2015, ISO 45001:2018
to meet OSHA's Lockout Tagout Standard 29 CFR, 1910.147 & 1910.269

KM Safetech Private Limited

QUALITY MANAGEMENT SYSTEM ISO 9001:2015

info@krmcorporation.com, info@krmloto.com, krmloto@gmail.com, wadhwrajinder@gmail.com

M: 00 91 9810 291 381, 8800 544 881, T: 00 91 129 - 4021 381

Postal Add: 615, Sector-15A, Faridabad-121007 Haryana - NCR (INDIA)
Regd. Office: 1H/31A, N.I.T. Faridabad-121001

www.krmloto.com www.krmcorporation.com, www.safetyloto.com
www.lotoappliances.com, www.lockouttagouts.com



MULTIFUNCTION CIRCUIT BREAKER LOCKOUT WITH FOLDABLE SCREW

- Multifunction Circuit Breaker Lockout is a versatile device fits on wide range of single, double, triple and four pole of electrical circuit breaker can be accommodates up to one lock and with the help of hasp lockout device can be used for group isolation.
- **Material** – High quality ABS with metallic nut
- KRM Multifunction Circuit Breaker Lockouts will lockout most type of breaker's lever. One size fits in all type of circuit breakers which is UV resistant and suitable for single, double, triple and four pole circuit breaker can be locked with single padlock and lockout hasp.
- Specialty of this lockout is that folding screw is there so that no extra tool required for any assistance.
- **Size** – Height 100mm, Width 66mm, Depth 14mm Locking Hole diameter 8 mm.
- **Color** – Red or can make any color as per the required quantity.



KRM-K-MCBL-SS

MODEL	Height	Width	Depth	Hole Dia
KRM-K-MCBL-SS	100 mm	6 mm	14 mm	8 mm

GSTIN No.: 06AAVPW8746Q1Z6,
PAN No.: AAVPW8746Q
TIN No.: 06821328889,
TAN no.: RTKKO3359G
IEC: 0509006116

M: 00 91 9810 291 381, 8800 544 881

Regd. Office: 1H/31-A, N.I.T, Faridabad-121001 (Haryana) Postal Office: 615, Sector-15-A, Faridabad-121007-Haryana-NCR-INDIA

www.krmcorporation.com | www.lockouttagouts.com | www.krmloto.com | www.locktagindia.com | www.lotoappliances.com



OEM Manufacturer & Global Supplier of
Lockout Tagout & Safety Products

to meet
OSHA'S Lockout Tagout Standard
29 CFR, 1910.147&1910.269



www.lotoappliances.com

Email: info@krmloto.com, info@krmcorporation.com, krmloto@gmail.com



GSTIN No.: 06AAECK2831L1Z1
PAN No.: AAECK2831L
TIN No.: 06824000112
CIN No.: U31903HR2011PTC042508
IEC: AAECK2831L

Telefax: 00 91 129 4021 381, 413 1381 (D)



KRM-LOTO
SAFETY PRODUCTS
safe loto

MULTIFUNCTION CIRCUIT BREAKER LOCKOUT WITH FOLDABLE SCREW

CE
Certified

KRM LOTO
EXPERT

Multifunction Circuit Breaker Lockout is a versatile device fits on wide range of single, double, triple and four pole of electrical circuit breaker can be accommodates up to one lock and with the help of hasp lockout device can be used for group isolation.

- **Material** – High quality ABS with metallic nut
- KRM Multifunction Circuit Breaker Lockouts will lockout most type of breaker's lever. One size fits in all type of circuit breakers which is UV resistant and suitable for single, double, triple and four pole circuit breaker can be locked with single padlock and lockout hasp.
- Specialty of this lockout is that folding screw is there so that no extra tool required for any assistance.
- **Size** – Height 100mm, Width 66mm, Depth 14mm Locking Hole diameter 8 mm.
- **Color** – Red or can make any color as per the required quantity.



KRM-K-MCBL-SS

KRM CORPORATION

ISO 9001 - 9001:2015, ISO EMS 14001:2015, ISO 45001:2018
to meet OSHA's Lockout Tagout Standard 29 CFR, 1910.147 & 1910.269

Postal Add: 615, Sector-15A, Faridabad-121007 Haryana - NCR (INDIA)
Regd. Office: 1H/31A, N.I.T. Faridabad-121001

KM Safetech Private Limited

QUALITY MANAGEMENT SYSTEM ISO 9001:2015

info@krmcorporation.com, info@krmloto.com, krmloto@gmail.com, wadhwrajinder@gmail.com

M: 00 91 9810 291 381, 8800 544 881, T: 00 91 129 - 4021 381

www.krmloto.com www.krmcorporation.com, www.safetyloto.com
www.lotoappliances.com, www.lockouttagouts.com

062

GSTIN No.: 06AACPW8746Q1Z6,
PAN No.: AACPW8746Q
TIN No.: 06821328889,
TAN no.: RTKKO3359G
IEC: 0509006116

M: 00 91 9810 291 381, 8900 544 881



OEM Manufacturer & Global Supplier of
Lockout Tagout & Safety Products

to meet
OSHA'S Lockout Tagout Standard
29 CFR, 1910.147&1910.269



www.lotoappliances.com



GSTIN No.: 06AAECK2831L1Z1
PAN No.: AAECK2831L
TIN No.: 06824000112
CIN No.: U31903HR2011PTC042508
IEC: AAECK2831L

Telefax: 00 91 129 4021 381, 413 1381 (D)

www.krmcorporation.com | www.lockouttagouts.com | www.krmloto.com | www.locktagindia.com | www.lotoappliances.com

KRM LOTO – UNIVERSAL FUSE / CIRCUIT BREAKER LOCKOUT

LOCKOUT/TAGOUT

- **Material** – High quality ABS with metallic nut
- KRM Universal Fuse/Circuit Breaker Lockouts used Unique locking mechanism that prevents device from being accidentally removed from fuse block.
- Available in plain and folding screw that is utilized to lock fuse holders of 20A to 400A current.
- **Color** – Red, Yellow, Green and Blue Or any color make as per the required quantity
- **Dimension** – Height 74mm, Width 34mm, Depth 15 mm, Hole dia 8.5 mm
- MCB Toggle Grip Height 7.5mm MCB Toggle Grip Width 13.5mm
- **Weight** – 20 gm

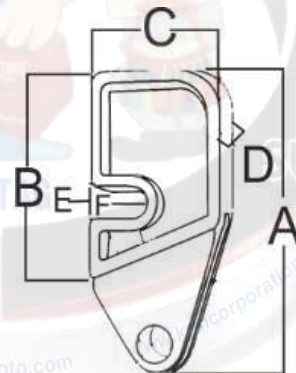

KRM-K-UFLD-1

MODELS	A	B	C	D	E	F
KRM-K-UFLD-1	74 mm	48 mm	34 mm	15 mm	7.5 mm	13.5 mm



OEM Manufacturer & Global Supplier of
Lockout Tagout & Safety Products

to meet
OSHA'S Lockout Tagout Standard
29 CFR, 1910.147&1910.269



www.lockoutappliance.com



Regd. Office: 1H/31-A, N.I.T, Faridabad-121001 (Haryana) Postal Office: 615, Sector-15-A, Faridabad-121007-Haryana-NCR-INDIA

www.krmcorporation.com | www.lockouttagouts.com | www.krmloto.com | www.locktagindia.com | www.lotoappliances.com



KRM-LOTO
SAFETY PRODUCTS
safe loto

CE
Certified

UNIVERSAL FUSE / CIRCUIT BREAKER LOCKOUT

EXPERT



KRM-K-UFLD-1



KRM-K-UFLD-SS



- **Material** – High quality ABS with metallic nut
- KRM Universal Fuse/Circuit Breaker Lockouts used Unique locking mechanism that prevents device from being accidentally removed from fuse block.
- Available in plain and folding screw that is utilized to lock fuse holders of 20A to 400A current.
- **Color** – Red, Yellow, Green and Blue Or any color make as per the required quantity
- **Dimension** – Height 74mm, Width 34mm, Depth 15 mm, Hole dia 8.5 mm
MCB Toggle Grip Height 7.5mm MCB Toggle Grip Width 13.5mm
- **Weight** – 20 gm for plain screw and 30 gm for foldable screw

MODELS	A	B	C	D	E	F
KRM-K-UFLD-1	74mm	48mm	34mm	15mm	7.5mm	13.5mm
KRM-K-UFLD-SS	74mm	48mm	34mm	15mm	7.5mm	13.5mm

KRM CORPORATION

ISO 9001:2015, ISO 14001:2015, ISO 45001:2018
to meet OSHA's Lockout Tagout Standard 29 CFR, 1910.147&1910.269

KM Safetech Private Limited

QUALITY MANAGEMENT SYSTEM ISO 9001:2015

info@krmcorporation.com, info@krmloto.com, krmloto@gmail.com, wadhwrajinder@gmail.com

M: 00 91 9810 291 381, 8800 544 881, T: 00 91 129 - 4021 381

Postal Add: 615, Sector-15A, Faridabad-121007
Regd. Office: 1H/31A, N.I.T. Faridabad-121001 Haryana - NCR (INDIA)

www.krmloto.com www.krmcorporation.com, www.safetyloto.com
www.lotoappliances.com, www.lockouttagouts.com

063



OEM Manufacturer & Global Supplier of
 Lockout Tagout & Safety Products

to meet
 OSHA'S Lockout Tagout Standard
 29 CFR, 1910.147&1910.269



www.lotoappliances.com



KRM LOTO – UNIVERSAL FUSE / CIRCUIT BREAKER LOCKOUT WITH FOLDABLE SCREW

- **Material** – High quality ABS with metallic nut
- KRM Universal Fuse/Circuit Breaker Lockouts used Unique locking mechanism that prevents device from being accidentally removed from fuse block.
- Available in plain and folding screw that is utilized to lock fuse holders of 20A to 400A current.
- **Color** – Red, Yellow, Green and Blue Or any color make as per the required quantity
- **Dimension** – Height 74mm, Width 34mm, Depth 15 mm, Hole dia 8.5 mm
- MCB Toggle Grip Height 7.5mm MCB Toggle Grip Width 13.5mm
- **Weight** – 30 gm

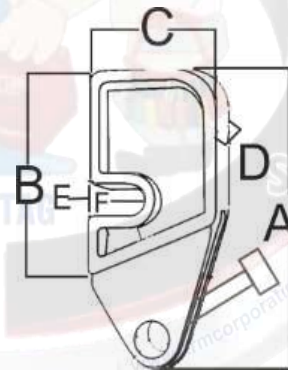

KRM-K-UFLD-SS

MODELS	A	B	C	D	E	F
KRM-K-UFLD-SS	74 mm	48 mm	34 mm	15 mm	7.5 mm	13.5 mm



OEM Manufacturer & Global Supplier of
Lockout Tagout & Safety Products

to meet
OSHA'S Lockout Tagout Standard
29 CFR, 1910.147&1910.269



UNIVERSAL FUSE / CIRCUIT BREAKER LOCKOUT

CE Certified



KRM-K-UFLD-1



KRM-K-UFLD-SS

- **Material** – High quality ABS with metallic nut
- KRM Universal Fuse/Circuit Breaker Lockouts used Unique locking mechanism that prevents device from being accidentally removed from fuse block.
- Available in plain and folding screw that is utilized to lock fuse holders of 20A to 400A current.
- **Color** – Red, Yellow, Green and Blue Or any color make as per the required quantity
- **Dimension** – Height 74mm, Width 34mm, Depth 15 mm, Hole dia 8.5 mm
MCB Toggle Grip Height 7.5mm MCB Toggle Grip Width 13.5mm
- **Weight** – 20 gm for plain screw and 30 gm for foldable screw

MODELS	A	B	C	D	E	F
KRM-K-UFLD-1	74mm	48mm	34mm	15mm	7.5mm	13.5mm
KRM-K-UFLD-SS	74mm	48mm	34mm	15mm	7.5mm	13.5mm



Lock Tag!!
 to compliance
 OSHA'S Lockout Tagout Standard
 29 CFR, 1910.147&1910.269



Regd. Office: 1H/31-A, N.I.T, Faridabad-121001 (Haryana) | Email: info@krmloto.com, info@krmcorporation.com, krmloto@gmail.com | Postal Office: 615, Sector-15-A, Faridabad-121007-Haryana-NCR-INDIA
www.krmcorporation.com | www.lockouttagouts.com | www.krmloto.com | www.locktagindia.com | www.lotoappliances.com
 Regd. Office: 1H/31-A, N.I.T, Faridabad-121001 (Haryana) | Postal Office: 615, Sector-15-A, Faridabad-121007-Haryana-NCR-INDIA
www.krmcorporation.com | www.lockouttagouts.com | www.krmloto.com | www.locktagindia.com | www.lotoappliances.com

KRM LOTO - UNIVERSAL LARGE CIRCUIT BREAKER LOCKOUT

LOCKOUT/TAGOUT

- Universal circuit Breaker lockout is a versatile device fits on wide range of electrical circuit breaker can be accommodates up to one lock and with the help of hasp lockout device can be used for group isolation.
- **Material** – High quality ABS with metallic nut
- Available in plain and folding screw that is utilized to lock
- Dimension – height 100 mm, width 53 mm, Toggle Height 19 mm, Thickness at locking end 106 mm, locking Hole diameter 9 mm, average Center internal Grip 42 mm
- **Color** – Red Or any color make as per the required quantity.
- **Weight** – 50gm

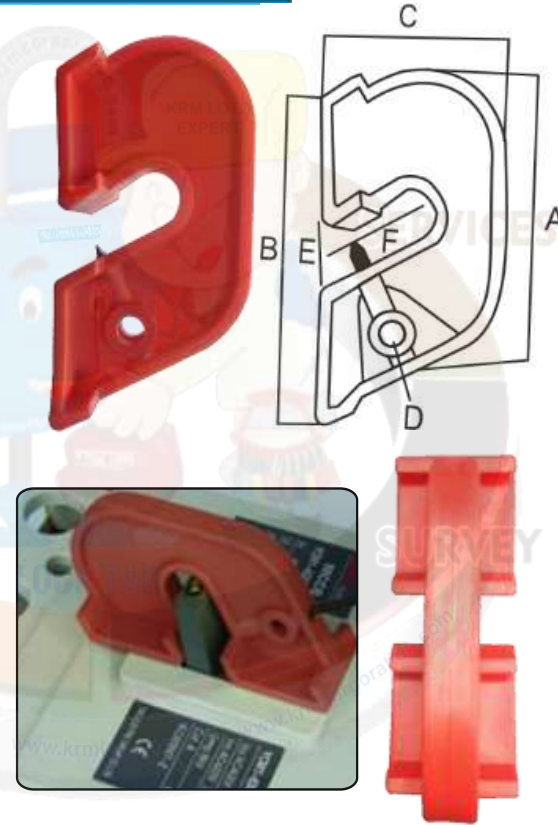

MODELS	A	B	C	D	E	F	Weight
KRM-K-ULCBL-N	100 mm	106 mm	53 mm	9 mm	19 mm	42 mm	50gm

KRM-K-ULCBL-N



OEM Manufacturer & Global Supplier of
Lockout Tagout & Safety Products

to meet
OSHA'S Lockout Tagout Standard
29 CFR, 1910.147&1910.269



www.lotoappliances.com



GSTIN No.: 06AAECK2831L1Z1
PAN No.: AAECK2831L
TIN No.: 06824000112
CIN No.: U31903HR2011PTC042508
IEC: AAECK2831L

Telefax: 00 91 129 4021 381, 413 1381 (D)

Regd. Office: 1H/31-A, N.I.T, Faridabad-121001 (Haryana) Postal Office: 615, Sector-15-A, Faridabad-121007-Haryana-NCR-INDIA

www.krmcorporation.com | www.lockouttagouts.com | www.krmloto.com | www.locktagindia.com | www.lotoappliances.com



KRM-LOTO
SAFETY PRODUCTS
safe loto

LARGE CIRCUIT BREAKER LOCKOUT

CE Certified



KRM-K-LCBL-T-R 1



KRM-K-LCBL-T-AS 1



KRM-K-LCBL-T-NS-1

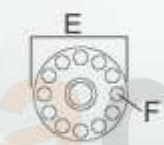
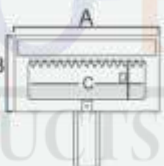

- Material - ABS Body with metallic screw.
- Large Circuit Breaker Lockout device with or without round arrangement at the back having molded teeth for strong gripping. In round large circuit breaker lockout device the bolt is attached with round portion and in simple device with round portion and in simple device with round we can tighten the screw with the help of screw driver.
- Screw Type - Plain or folding screw for simple device and then adjust the round for tightening screw in round lockout device.
- Twelve holes to place the padlock in round type (KRM-K-LCBL-T-R-1) & single hole in (KRM-K-LCBL-T-AS1, KRM-K-LCBL-T-NS1) and one rectangle for isolate large MCB Toggle Grip of circuit breaker.
- It is suitable for 227V & above Circuit breakers.
- Dimensions – Height - 94mm, Width - 49mm, Inner Width - 75mm, Inner Height - 20mm hole diameter 8mm.
- Weight – 36 gm for simple screw, 45 gm for adjustable screw and 67 gm for round type large circuit breaker.
- Color - Standard color red or it can make as per the quantity required quantity.

MODELS	A	B	C	D	E	F	G
KRM-K-LCBL-T-R 1	94mm	49mm	75mm	20mm	61mm	8mm	85mm
KRM-K-LCBL-T-AS 1	94mm	49mm	75mm	20mm	-	-	-
KRM-K-LCBL-T-NS 1	94mm	49mm	75mm	20mm	-	-	-

KRM CORPORATION

ISO 9001:2015, ISO 14001:2015, ISO 45001:2018
to meet OSHA's Lockout Tagout Standard 29 CFR, 1910.147 & 1910.269

KM Safetech Private Limited

QUALITY MANAGEMENT SYSTEM ISO QMS 9001:2015

M: 00 91 9810 291 381, 8800 544 881, T: 00 91 129 - 4021 381

info@krmcorporation.com, info@krmloto.com, krmloto@gmail.com, wadhwarajinder@gmail.com

Postal Add: 615, Sector-15A, Faridabad-121007
Regd. Office: 1H/31A, N.I.T, Faridabad-121001 Haryana - NCR (INDIA)

www.krmloto.com www.krmcorporation.com, www.safetyloto.com
www.lotoappliances.com, www.lockouttagouts.com

064



OEM Manufacturer & Global Supplier of
Lockout Tagout & Safety Products

to meet
OSHA'S Lockout Tagout Standard
29 CFR, 1910.147&1910.269



Regd. Office: 1H/31-A, N.I.T, Faridabad-121001 (Haryana) | Postal Office: 615, Sector-15-A, Faridabad-121007-Haryana-NCR-INDIA

www.krmcorporation.com | www.lockouttagouts.com | www.krmloto.com | www.locktagindia.com | www.lotoappliances.com

KRM LOTO – LARGE CIRCUIT BREAKER LOCKOUT WITH ADJUSTABLE SCREW

- **Material** - ABS Body with metallic screw.
- Large Circuit Breaker Lockout device with or without round arrangement at the back having molded teeth for strong gripping. In round large circuit breaker lockout device the bolt is attached with round portion and in simple device with round portion and in simple device with round we can tighten the screw with the help of screw driver.
- Screw Type - Plain or folding screw for simple device and then adjust the round for tightening screw in round lockout device.
- single hole and one rectangle for isolate large MCB Toggle Grip of circuit breaker.
- It is suitable for 227V & above Circuit breakers.
- **Dimensions** – Height - 94mm, Width - 49mm, Inner Width - 75mm, Inner Height - 20mm hole diameter 8mm.
- **Weight** – 45 gm
- **Color** - Standard color red or it can make as per the quantity required quantity.

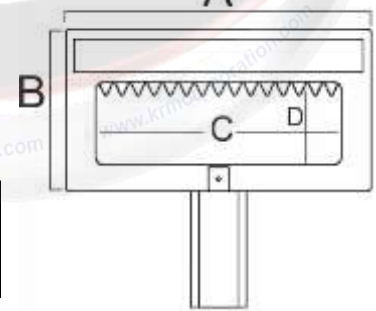

MODELS	A	B	C	D
KRM-K-LCBL-T-AS-1	94 mm	49 mm	75 mm	20 mm



OEM Manufacturer & Global Supplier of
Lockout Tagout & Safety Products

to meet
OSHA'S Lockout Tagout Standard
29 CFR, 1910.147&1910.269

www.lotoappliances.com

Email: info@krmloto.com, info@krmcorporation.com, krmloto@gmail.com

Regd. Office: 1H/31-A, N.I.T, Faridabad-121001 (Haryana) Postal Office: 615, Sector-15-A, Faridabad-121007-Haryana-NCR-INDIA

www.krmcorporation.com | www.lockouttagouts.com | www.krmloto.com | www.locktagindia.com | www.lotoappliances.com

KRM LOTO
SAFETY PRODUCTS

safe loto

LARGE CIRCUIT BREAKER LOCKOUT

CE Certified

- Material - ABS Body with metallic screw.
- Large Circuit Breaker Lockout device with or without round arrangement at the back having molded teeth for strong gripping. In round large circuit breaker lockout device the bolt is attached with round portion and in simple device with round portion and in simple device with round we can tighten the screw with the help of screw driver.
- Screw Type - Plain or folding screw for simple device and then adjust the round for tightening screw in round lockout device.
- Twelve holes to place the padlock in round type (KRM-K-LCBL-T-R-1) & single hole in (KRM-K-LCBL-T-AS1, KRM-K-LCBL-T-NS1) and one rectangle for isolate large MCB Toggle Grip of circuit breaker.
- It is suitable for 227V & above Circuit breakers.
- Dimensions – Height - 94mm, Width - 49mm, Inner Width - 75mm, Inner Height - 20mm hole diameter 8mm.
- Weight – 36 gm for simple screw, 45 gm for adjustable screw and 67 gm for round type large circuit breaker.
- Color - Standard color red or it can make as per the quantity required quantity.

KRM-K-LCBL-T-R 1

KRM-K-LCBL-T-AS 1

KRM-K-LCBL-T-NS-1

MODELS	A	B	C	D	E	F	G
KRM-K-LCBL-T-R 1	94mm	49mm	75mm	20mm	61mm	8mm	85mm
KRM-K-LCBL-T-AS 1	94mm	49mm	75mm	20mm	-	-	-
KRM-K-LCBL-T-NS 1	94mm	49mm	75mm	20mm	-	-	-



OEM Manufacturer & Global Supplier of
Lockout Tagout & Safety Products

to meet
OSHA'S Lockout Tagout Standard
29 CFR, 1910.147&1910.269

www.lotoappliances.com

Email: info@krmloto.com, info@krmcorporation.com, krmloto@gmail.com

Regd. Office: 1H/31-A, N.I.T, Faridabad-121001 (Haryana) Postal Office: 615, Sector-15-A, Faridabad-121007-Haryana-NCR-INDIA

www.krmcorporation.com

www.lockouttagouts.com

www.krmloto.com

www.locktagindia.com

www.lotoappliances.com

KRM LOTO – LARGE CIRCUIT BREAKER LOCKOUT

- Material - ABS Body with metallic screw.
- Large Circuit Breaker Lockout device with or without round arrangement at the back having molded teeth for strong gripping. In round large circuit breaker lockout device the bolt is attached with round portion and in simple device with round portion and in simple device with round we can tighten the screw with the help of screw driver.
- Screw Type - Plain or folding screw for simple device and then adjust the round for tightening screw in round lockout device.
- Twelve holes to place the padlock in round type and one rectangle for isolate large MCB Toggle Grip of circuit breaker.
- It is suitable for 227V & above Circuit breakers.
- **Dimensions** – Height - 94mm, Width - 49mm, Inner Width - 75mm, Inner Height - 20mm hole diameter 8mm.
- **Weight** – 60 gm
- **Color** - Standard color red or it can make as per the quantity required quantity.



KRM-K-LCBL-T-R-1

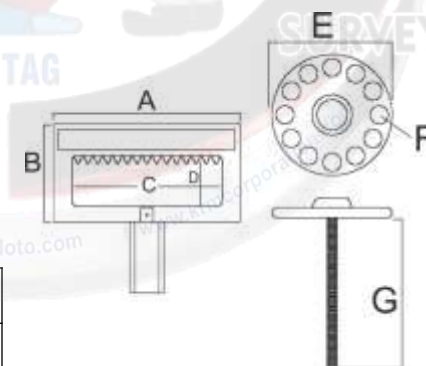

MODELS	A	B	C	D	E	F	G
KRM-K-LCBL-T-R-1	94 mm	49 mm	75 mm	20 mm	61 mm	8 mm	85 mm



OEM Manufacturer & Global Supplier of
Lockout Tagout & Safety Products

to meet
OSHA'S Lockout Tagout Standard
29 CFR, 1910.147&1910.269



www.lotoappliances.com



GSTIN No.: 06AAECK2831L1Z1
PAN No.: AAECK2831L
TIN No.: 06824000112
CIN No.: U31903HR2011PTC042508
IEC: AAECK2831L

Telefax: 00 91 129 4021 381, 413 1381 (D)

Regd. Office: 1H/31-A, N.I.T, Faridabad-121001 (Haryana) Postal Office: 615, Sector-15-A, Faridabad-121007-Haryana-NCR-INDIA

www.krmcorporation.com | www.lockouttagouts.com | www.krmloto.com | www.locktagindia.com | www.lotoappliances.com

KRM LOTO
SAFETY PRODUCTS

safe loto

LARGE CIRCUIT BREAKER LOCKOUT

CE Certified

- Material - ABS Body with metallic screw.
- Large Circuit Breaker Lockout device with or without round arrangement at the back having molded teeth for strong gripping. In round large circuit breaker lockout device the bolt is attached with round portion and in simple device with round portion and in simple device with round we can tighten the screw with the help of screw driver.
- Screw Type - Plain or folding screw for simple device and then adjust the round for tightening screw in round lockout device.
- Twelve holes to place the padlock in round type (KRM-K-LCBL-T-R-1) & single hole in (KRM-K-LCBL-T-AS1, KRM-K-LCBL-T-NS1) and one rectangle for isolate large MCB Toggle Grip of circuit breaker.
- It is suitable for 227V & above Circuit breakers.
- Dimensions – Height - 94mm, Width - 49mm, Inner Width - 75mm, Inner Height - 20mm hole diameter 8mm.
- Weight – 36 gm for simple screw, 45 gm for adjustable screw and 67 gm for round type large circuit breaker.
- Color - Standard color red or it can make as per the quantity required quantity.

KRM-K-LCBL-T-R 1

KRM-K-LCBL-T-AS 1

KRM-K-LCBL-T-NS-1

MODELS	A	B	C	D	E	F	G
KRM-K-LCBL-T-R 1	94mm	49mm	75mm	20mm	61mm	8mm	85mm
KRM-K-LCBL-T-AS 1	94mm	49mm	75mm	20mm	-	-	-
KRM-K-LCBL-T-NS 1	94mm	49mm	75mm	20mm	-	-	-

GSTIN No.: 06AAVPW8746Q1Z6,
PAN No.: AAVPW8746Q
TIN No.: 06821328889,
TAN no.: RTKKO3359G
IEC: 0509006116

M: 00 91 9810 291 381, 8900 544 881



OEM Manufacturer & Global Supplier of
Lockout Tagout & Safety Products

to meet
OSHA'S Lockout Tagout Standard
29 CFR, 1910.147&1910.269



www.lotoappliances.com



GSTIN No.: 06AAECK2831L1Z1
PAN No.: AAECK2831L
TIN No.: 06824000112
CIN No.: U31903HR2011PTC042508
IEC: AAECK2831L

Telefax: 00 91 129 4021 381, 413 1381 (D)

Regd. Office: 1H/31-A, N.I.T, Faridabad-121001 (Haryana) | Postal Office: 615, Sector-15-A, Faridabad-121007-Haryana-NCR-INDIA

www.krmcorporation.com | www.lockouttagouts.com | www.krmloto.com | www.locktagindia.com | www.lotoappliances.com

KRM LOTO – CIRCUIT BREAKER LOCKOUT RAIL KIT

- For providing protection to different energy sources for group isolation when multiple authorized employees need to lockout the same energy sources at a time to meet OSHA's Lockout Tagout Standard.
- Material – ABS.
- KRM Lockout Breaker Kit's body is in two parts, available with two rails and two blocking bars in which rails are available with pre adhesive and holes for drilling to install the device.
- Device is having two locking rails and two blocking arms.
- It can be installed on electrical panel or circuit breaker directly, for lockout purpose 6 holes are available.
- Suitable for Over Size MCB Switches to lock.
- This lockout device is suitable for 480 V to 600 V.
- **Dimension** – Blocking Rail Height - 100mm & Blocking Bar Height - 200mm
Blocking arm/bar is available in two different color option, green color indicates locked 'OFF' situation and color red indicates 'ON' situation.
- **Weight** – 50 gm
- **Color** – Blocking Bar is of Red and Green color alternatives and Locking Rail is of yellow color.



KRM LOTO
EXPERT

KRM-K-BLK



GSTIN No.: 06AAVPW8746Q1Z6,
PAN No.: AAVPW8746Q
TIN No.: 06821328889,
TAN no.: RTKKO3359G
IEC: 0509006116

M: 00 91 9810 291 381, 8800 544 881

Regd. Office: 1H/31-A, N.I.T, Faridabad-121001 (Haryana) Postal Office: 615, Sector-15-A, Faridabad-121007-Haryana-NCR-INDIA

www.krmcorporation.com

www.lockouttagouts.com

www.krmloto.com

www.locktagindia.com

www.lotoappliances.com



OEM Manufacturer & Global Supplier of
Lockout Tagout & Safety Products

to meet
OSHA'S Lockout Tagout Standard
29 CFR, 1910.147&1910.269

www.lotoappliances.com



GSTIN No.: 06AAECK2831L1Z1
PAN No.: AAECK2831L
TIN No.: 06824000112
CIN No.: U31903HR2011PTC042508
IEC: AAECK2831L

Telefax: 00 91 129 4021 381, 413 1381 (D)



KRM-LOTO
SAFETY PRODUCTS
safe loto

CIRCUIT BREAKER LOCKOUT RAIL KIT

CE
Certified



KRM-K-BLK

- For providing protection to different energy sources for group isolation when multiple authorized employees need to lockout the same energy sources at a time to meet OSHA's Lockout Tagout Standard.
- Material – ABS.
- KRM Lockout Breaker Kit's body is in two parts, available with two rails and two blocking bars in which rails are available with pre adhesive and holes for drilling to install the device.
- Device is having two locking rails and two blocking arms.
- It can be installed on electrical panel or circuit breaker directly, for lockout purpose 6 holes are available.
- Suitable for Over Size MCB Switches to lock.
- This lockout device is suitable for 480 V to 600 V.
- Dimension – Blocking Rail Height - 100mm & Blocking Bar Height - 200mm
- Blocking arm/bar is available in two different color option, green color indicates locked 'OFF' situation and color red indicates 'ON' situation.
- Weight – 50 gm
- Color – Blocking Bar is of Red and Green color alternatives and Locking Rail is of yellow color.

KRM CORPORATION

ISO 9001:2015, ISO EMS 14001:2015, ISO 45001:2018
to meet OSHA's Lockout Tagout Standard 29 CFR, 1910.147&1910.269

KM Safetech Private Limited

QUALITY MANAGEMENT SYSTEM ISO 9001:2015

info@krmcorporation.com, info@krmloto.com, krmloto@gmail.com, wadhwrajinder@gmail.com

M: 00 91 9810 291 381, 8800 544 881, T: 00 91 129 - 4021 381

Postal Add: 615, Sector-15A, Faridabad-121007 Haryana - NCR (INDIA)
Regd. Office: 1H/31A, N.I.T. Faridabad-121001

www.krmloto.com
www.krmcorporation.com, www.safeteloto.com
www.lotoappliances.com, www.lockouttagouts.com



OEM Manufacturer & Global Supplier of
 Lockout Tagout & Safety Products

to meet
 OSHA'S Lockout Tagout Standard
 29 CFR, 1910.147&1910.269



www.lotoappliances.com



KRM LOTO – GRIP TIGHT – CIRCUIT BREAKER LOCKOUT

- **Material** – Made of ABS with Metal.
- Locks out Circuit Breaker with simple thumb turn to adjust and then close clamping handle for the grip on the MCB
- **Application** – Suits to One Way or Two - Way Switch
- Easy to handle and suitable for indoor and outdoor applications
- **Color** – Red or any color can make as per required quantity.
- This is suitable for 120V



KRM-K-CBLM-101

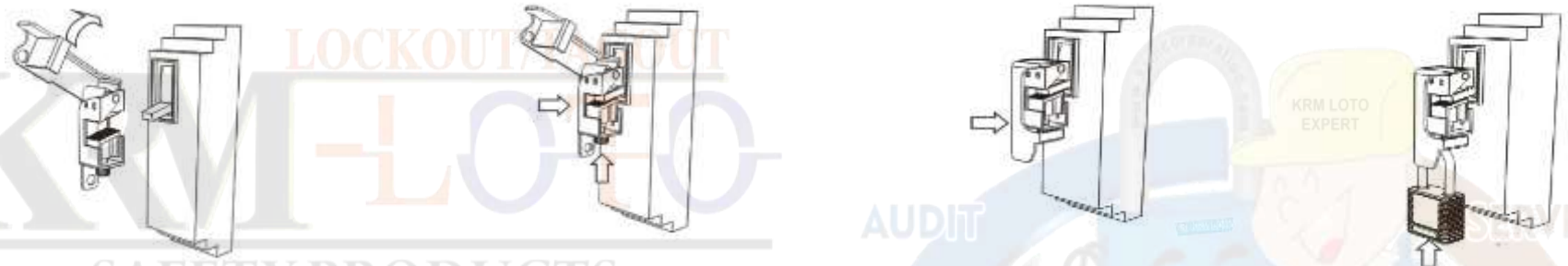

STEP – 1:- Open the red lockout handle.

STEP – 2:- Fix the lockout on the circuit from one side, screw the black button clockwise to tighten and then close the red handle of lockout device.

STEP – 3:- Adjust the red lock handle to the closed position. Always confirm the circuit breaker is in OFF position.

STEP – 4:- Finally put the padlock and tag through it and lock the device.

MODELS	HEIGHT	WIDTH	DEPTH	HOLE DIA	WEIGHT
KRM-K-CBLM-101	74 mm	20 mm	20 mm	8.5 mm	20 gm



OEM Manufacturer & Global Supplier of
Lockout Tagout & Safety Products

to meet
OSHA'S Lockout Tagout Standard
29 CFR, 1910.147&1910.269



www.locktagindia.com



GRIP TIGHT – CIRCUIT BREAKER LOCKOUT

CE
Certified

- Material – Made of ABS with Metal.
- Locks out Circuit Breaker with simple thumb turn to adjust and then close clamping handle for the grip on the MCB
- Application – Suits to One Way or Two - Way Switch
- Easy to handle and suitable for indoor and outdoor applications
- Color – Red or any color can make as per required quantity.
- KRM-K-CBLM-101 is suitable for 120V & KRM-K-CBLL-102 is suitable for 240V



KRM-K-CBLM-101



KRM-K-CBLL-102



STEP – 1:- Open the red lockout handle.



STEP – 2:- Fit the lockout on the circuit from one side, screw the black button clockwise to tighten and then close the red handle of lockout device.



STEP – 3:- Adjust the red lock handle to the closed position. Always confirm the circuit breaker is in OFF position.



STEP – 4:- Finally put the padlock and tag through it and lock the device.

MODELS	HEIGHT	WIDTH	DEPTH	HOLE DIA	WEIGHT
KRM-K-CBLM-101	74mm	20mm	20mm	8.5mm	20gm
KRM-K-CBLL-102	86mm	28mm	30mm	8.5mm	30gm



OEM Manufacturer & Global Supplier of
 Lockout Tagout & Safety Products

to meet
 OSHA'S Lockout Tagout Standard
 29 CFR, 1910.147&1910.269



www.lotoappliances.com



KRM LOTO – GRIP TIGHT – CIRCUIT BREAKER LOCKOUT

- **Material** – Made of ABS with Metal.
- Locks out Circuit Breaker with simple thumb turn to adjust and then close clamping handle for the grip on the MCB
- **Application** – Suits to One Way or Two - Way Switch
- Easy to handle and suitable for indoor and outdoor applications
- **Color** – Red or any color can make as per required quantity.
- This is suitable for 240V



KRM-K-CBLL-102

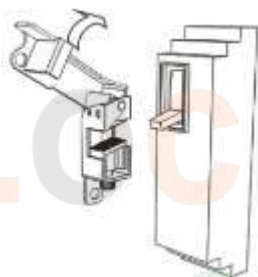

STEP – 1:- Open the red lockout handle.

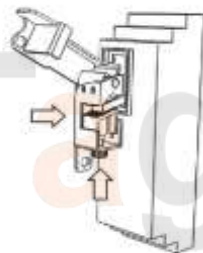

STEP – 2:- Fix the lockout on the circuit from one side, screw the black button clockwise to tighten and then close the red handle of lockout device.



STEP – 3:- Adjust the red lock handle to the closed position. Always confirm the circuit breaker is in OFF position.



STEP – 4:- Finally put the padlock and tag through it and lock the device.

MODELS	HEIGHT	WIDTH	DEPTH	HOLE DIA	WEIGHT
KRM-K-CBLL-102	86 mm	28 mm	30 mm	8.5 mm	30 gm



OEM Manufacturer & Global Supplier of
Lockout Tagout & Safety Products

to meet
OSHA'S Lockout Tagout Standard
29 CFR, 1910.147&1910.269



www.locktagindia.com



GRIP TIGHT – CIRCUIT BREAKER LOCKOUT

CE Certified

- Material – Made of ABS with Metal.
- Locks out Circuit Breaker with simple thumb turn to adjust and then close clamping handle for the grip on the MCB
- Application – Suits to One Way or Two - Way Switch
- Easy to handle and suitable for indoor and outdoor applications
- Color – Red or any color can make as per required quantity.
- KRM-K-CBLM-101 is suitable for 120V & KRM-K-CBLL-102 is suitable for 240V



KRM-K-CBLM-101



KRM-K-CBLL-102



STEP – 1:- Open the red lockout handle.



STEP – 2:- Fit the lockout on the circuit from one side, screw the black button clockwise to tighten and then close the red handle of lockout device.



STEP – 3:- Adjust the red lock handle to the closed position. Always confirm the circuit breaker is in OFF position.



STEP – 4:- Finally put the padlock and tag through it and lock the device.

MODELS	HEIGHT	WIDTH	DEPTH	HOLE DIA	WEIGHT
KRM-K-CBLM-101	74mm	20mm	20mm	8.5mm	20gm
KRM-K-CBLL-102	86mm	28mm	30mm	8.5mm	30gm

GSTIN No.: 06AACPW8746Q1Z6,
PAN No.: AACPW8746Q
TIN No.: 06821328889,
TAN no.: RTKKO3359G
IEC: 0509006116

M: 00 91 9810 291 381, 8900 544 881



OEM Manufacturer & Global Supplier of
Lockout Tagout & Safety Products

to meet
OSHA'S Lockout Tagout Standard
29 CFR, 1910.147&1910.269



www.lotoappliances.com



GSTIN No.: 06AAECK2831L1ZI
PAN No.: AAECK2831L
TIN No.: 06824000112
CIN No.: U31903HR2011PTC042508
IEC: AAECK2831L

Telefax: 00 91 129 4021 381, 413 1381 (D)

KRM LOTO – CLAMP ON – CIRCUIT BREAKER LOCKOUT

- **Material** - Made of ABS with metallic screw
- Can be used to lock circuit breakers of 120/270V.
- **Screw Type** - Plain screw type for simple device and then adjust the round for tightening screw in round lockout device.
- Insulated and anti corrosive
- Suitable for single pole Type MCB
- **Weight** – 20gm



KRM LOTO
EXPERT



KRM-K-CBLS-105

MODELS	HEIGHT	WIDTH	DEPTH	MCB Toggle Width	MCB Toggle Height	VOLTAGE	HOLE DIA
KRM-K-CBLS-105	31 mm	29 mm	55 mm	16.5 mm	12 mm	120/270V	7.5mm



OEM Manufacturer & Global Supplier of
Lockout Tagout & Safety Products

to meet
OSHA'S Lockout Tagout Standard
29 CFR, 1910.147&1910.269



www.lockoutappliances.com



Regd. Office: 1H/31-A, N.I.T, Faridabad-121001 (Haryana) | Postal Office: 615, Sector-15-A, Faridabad-121007-Haryana-NCR-INDIA

www.krmcorporation.com | www.lockouttagouts.com | www.krmloto.com | www.locktagindia.com | www.lotoappliances.com

safe loto

CLAMP ON – CIRCUIT BREAKER LOCKOUT

CE Certified

- Material - Made of ABS with metallic screw
- Can be used to lock circuit breakers of 120/270V or 480/600V or 480/600V or Above.
- Screw Type - Plain screw type for simple device and then adjust the round for tightening screw in round lockout device.
- Insulated and anti corrosive
- KRM-K-CBLS-105 Suitable for single pole Type MCB. KRM-K-CBLM-104 & KRM-K-CBLL 103 Suitable for Double Triple and Multi-Pole Type MCB.

KRM-K-CBLS-105

KRM-K-CBLM-104

KRM-K-CBLL-103

STEP - 1: - Open the red lockout handle

STEP - 2: - Fix the lockout on the circuit breaker, clockwise tighten the back button screw and afterwards close the red lockout handle

STEP - 3: - Adjust the red lockout handle to close the position. Always confirm that the circuit breaker is in OFF position.

STEP - 4: - Put the padlock and tag through it and then lockout.

MODELS	HEIGHT	WIDTH	DEPTH	MCB TOGGLE WIDTH	MCB TOGGLE HEIGHT	VOLTAGE	HOLE DIA
KRM-K-CBLS-105	31mm	29mm	55mm	16.5mm	12mm	120/270V	7.5mm
KRM-K-CBLM-104	41mm	60mm	74mm	41mm	16mm	480/600V	7.5mm
KRM-K-CBLL-103	52mm	90mm	76mm	72mm	20mm	480/600V or Above	7.5mm

GSTIN No.: 06AACPW8746Q1Z6,
PAN No.: AACPW8746Q
TIN No.: 06821328889,
TAN no.: RTKKO3359G
IEC: 0509006116

M: 00 91 9810 291 381, 8900 544 881



OEM Manufacturer & Global Supplier of
Lockout Tagout & Safety Products

to meet
OSHA'S Lockout Tagout Standard
29 CFR, 1910.147&1910.269



www.lotoappliances.com



GSTIN No.: 06AAECK2831L1Z1
PAN No.: AAECK2831L
TIN No.: 06824000112
CIN No.: U31903HR2011PTC042508
IEC: AAECK2831L

Telefax: 00 91 129 4021 381, 413 1381 (D)

Regd. Office: 1H/31-A, N.I.T, Faridabad-121001 (Haryana) Postal Office: 615, Sector-15-A, Faridabad-121007-Haryana-NCR-INDIA

www.krmcorporation.com | www.lockouttagouts.com | www.krmloto.com | www.locktagindia.com | www.lotoappliances.com

KRM LOTO – CLAMP ON – CIRCUIT BREAKER LOCKOUT

LOCKOUT/TAGOUT

- **Material** - Made of ABS with metallic screw
- Can be used to lock circuit breakers of 480/600V
- **Screw Type** - Plain screw type for simple device and then adjust the round for tightening screw in round lockout device.
- Insulated and anti corrosive
- Suitable for Double Triple and Multi-Pole Type MCB.
- **Weight** – 50gm



KRM-K-CBLM-104

MODELS	HEIGHT	WIDTH	DEPTH	MCB Toggle Width	MCB Toggle Height	VOLTAGE	HOLE DIA
KRM-K-CBLM-104	41 mm	60 mm	74 mm	41 mm	16 mm	480/600V	7.5mm



OEM Manufacturer & Global Supplier of
Lockout Tagout & Safety Products

to meet
OSHA'S Lockout Tagout Standard
29 CFR, 1910.147&1910.269



www.lotoappliances.com



Regd. Office: 1H/31-A, N.I.T, Faridabad-121001 (Haryana) | Postal Office: 615, Sector-15-A, Faridabad-121007-Haryana-NCR-INDIA
www.krmcorporation.com | www.lockouttagouts.com | www.krmloto.com | www.locktagindia.com | www.lotoappliances.com

CLAMP ON – CIRCUIT BREAKER LOCKOUT

CE Certified



- Material - Made of ABS with metallic screw
- Can be used to lock circuit breakers of 120/270V or 480/600V or 480/600V or Above.
- Screw Type - Plain screw type for simple device and then adjust the round for tightening screw in round lockout device.
- Insulated and anti corrosive
- KRM-K-CBLS-105 Suitable for single pole Type MCB. KRM-K-CBLM-104 & KRM-K-CBLL 103 Suitable for Double Triple and Multi-Pole Type MCB.



KRM-K-CBLS-105



KRM-K-CBLM-104



KRM-K-CBLL-103



STEP - 1: - Open the red lockout handle



STEP - 2: - Fix the lockout on the circuit breaker, clockwise tighten the back button screw and afterwards close the red lockout handle



STEP - 3: - Adjust the red lockout handle to close the position. Always confirm that the circuit breaker is in OFF position.



STEP - 4: - Put the padlock and tag through it and then lockout.

MODELS	HEIGHT	WIDTH	DEPTH	MCB TOGGLE WIDTH	MCB TOGGLE HEIGHT	VOLTAGE	HOLE DIA
KRM-K-CBLS-105	31mm	29mm	55mm	16.5mm	12mm	120/270V	7.5mm
KRM-K-CBLM-104	41mm	60mm	74mm	41mm	16mm	480/600V	7.5mm
KRM-K-CBLL-103	52mm	90mm	76mm	72mm	20mm	480/600V or Above	7.5mm

KRM CORPORATION

ISO 9001 - 9001:2015, ISO EMS 14001:2015, ISO OHSMS 45001:2018
to meet OSHA's Lockout Tagout Standard 29 CFR, 1910.147&1910.269

KM Safetech Private Limited

QUALITY MANAGEMENT SYSTEM ISO 9001:2015

M: 00 91 9810 291 381, 8800 544 881, T: 00 91 129 - 4021 381

info@krmcorporation.com, info@krmloto.com, krmloto@gmail.com, wadhwarajinder@gmail.com

Postal Add: 615, Sector-15A, Faridabad-121007
Regd. Office: 1H/31A, N.I.T. Faridabad-121001 Haryana - NCR (INDIA)

www.krmloto.com | www.krmcorporation.com, www.safetyloto.com
www.lotoappliances.com, www.lockouttagouts.com



OEM Manufacturer & Global Supplier of
Lockout Tagout & Safety Products

to meet
OSHA'S Lockout Tagout Standard
29 CFR, 1910.147&1910.269



www.lotoappliances.com



safe loto

CLAMP ON – CIRCUIT BREAKER LOCKOUT

CE Certified

- Material - Made of ABS with metallic screw
- Can be used to lock circuit breakers of 120/270V or 480/600V or 480/600V or Above.
- Screw Type - Plain screw type for simple device and then adjust the round for tightening screw in round lockout device.
- Insulated and anti corrosive
- KRM-K-CBLS-105 Suitable for single pole Type MCB. KRM-K-CBLM-104 & KRM-K-CBLL 103 Suitable for Double Triple and Multi-Pole Type MCB.

KRM-K-CBLS-105

KRM-K-CBLM-104

KRM-K-CBLL-103

STEP - 1: - Open the red lockout handle

STEP - 2: - Fix the lockout on the circuit breaker, clockwise tighten the back button screw and afterwards close the red lockout handle

STEP - 3: - Adjust the red lockout handle to close the position. Always confirm that the circuit breaker is in OFF position.

STEP - 4: - Put the padlock and tag through it and then lockout.

MODELS	HEIGHT	WIDTH	DEPTH	MCB TOGGLE WIDTH	MCB TOGGLE HEIGHT	VOLTAGE	HOLE DIA
KRM-K-CBLS-105	31mm	29mm	55mm	16.5mm	12mm	120/270V	7.5mm
KRM-K-CBLM-104	41mm	60mm	74mm	41mm	16mm	480/600V	7.5mm
KRM-K-CBLL-103	52mm	90mm	76mm	72mm	20mm	480/600V or Above	7.5mm

GSTIN No.: 06AACPW8746Q1Z6,
PAN No.: AACPW8746Q
TIN No.: 06821328889,
TAN no.: RTKKO3359G
IEC: 0509006116

M: 00 91 9810 291 381, 8900 544 881



OEM Manufacturer & Global Supplier of
Lockout Tagout & Safety Products

to meet
OSHA'S Lockout Tagout Standard
29 CFR, 1910.147&1910.269



www.lotoappliances.com



GSTIN No.: 06AAECK2831L1Z1
PAN No.: AAECK2831L
TIN No.: 06824000112
CIN No.: U31903HR2011PTC042508
IEC: AAECK2831L

Telefax: 00 91 129 4021 381, 413 1381 (D)

Regd. Office: 1H/31-A, N.I.T, Faridabad-121001 (Haryana) Postal Office: 615, Sector-15-A, Faridabad-121007-Haryana-NCR-INDIA

www.krmcorporation.com | www.lockouttagouts.com | www.krmloto.com | www.locktagindia.com | www.lotoappliances.com

KRM LOTO – SNAP ON BREAKER LOCKOUT DEVICE

- **Material** – ABS
- KRM Snap On Breaker Lockout Device is suitable for breakers having holes on switch's tongue. Also having double cavities space that can be accommodated on different size switch tongues.
- Only one padlock can be placed on the device for locking.
- Specially designed for 120 Volts of Snap on circuit breakers.
- **Dimension** – Height – 54mm, Width – 21mm, Depth – 8.5mm
- **Hole Diameter** – 7.5 mm
- **Color** – Standard color Red or can make as per the required quantity.
- **Weight** – 5gm



KRM-K-SOBLD

MODELS	HEIGHT	WIDTH	DEPTH	HOLE DIA
KRM-K-SOBLD	54 mm	21 mm	8.5 mm	7.5 mm



OEM Manufacturer & Global Supplier of
Lockout Tagout & Safety Products

to meet
OSHA'S Lockout Tagout Standard
29 CFR, 1910.147&1910.269



www.locktagindia.com



LOCKOUT/TAGOUT



SNAP ON BREAKER LOCKOUT KIT

CE
Certified



KRM-K-SOBLD

- Material – ABS
- KRM Snap On Breaker Lockout Device is suitable for breakers having holes on switch's tongue. Also having double cavities space that can be accommodated on different size switch tongues.
- Only one padlock can be placed on the device for locking.
- Specially designed for 120 Volts of Snap on circuit breakers.
- Dimension – Height – 54mm, Width – 21mm, Depth – 8.5mm
- Hole Diameter – 7.5 mm
- Color – Standard color Red or can make as per the required quantity.
- Weight – 5 gm

MODELS	HEIGHT	WIDTH	DEPTH	HOLE DIA
KRM-K-SOBLD	54mm	21mm	8.5mm	7.5mm

GSTIN No.: 06AACPW8746Q1Z6,
PAN No.: AACPW8746Q
TIN No.: 06821328889,
TAN no.: RTKKO3359G
IEC: 0509006116

M: 00 91 9810 291 381, 8900 544 881



OEM Manufacturer & Global Supplier of
Lockout Tagout & Safety Products

to meet
OSHA'S Lockout Tagout Standard
29 CFR, 1910.147&1910.269



www.lotoappliances.com



GSTIN No.: 06AAECK2831L1Z1
PAN No.: AAECK2831L
TIN No.: 06824000112
CIN No.: U31903HR2011PTC042508
IEC: AAECK2831L

Telefax: 00 91 129 4021 381, 413 1381 (D)

Regd. Office: 1H/31-A, N.I.T, Faridabad-121001 (Haryana) Postal Office: 615, Sector-15-A, Faridabad-121007-Haryana-NCR-INDIA

www.krmcorporation.com | www.lockouttagouts.com | www.krmloto.com | www.locktagindia.com | www.lotoappliances.com

KRM LOTO – CIRCUIT BREAKER LOCKOUT

- **Material** – Made of Polycarbonate
- Durable and are quick and easy to apply.
- Circuit Breaker Lockout is designed to fit slightly larger breakers.
- Can be used for double pole circuit breakers lockout application.
- **Color** – Standard color red or it can make as per the quantity required quantity.
- **Weight** – 30gm



KRM LOTO
EXPERT



KRM-K-CBL-1

MODELS	HEIGHT	WIDTH	DEPTH	HOLE DIA
KRM-K-CBL-1	48 mm	60 mm	33 mm	8 mm

GSTIN No.: 06AAMPW8746Q1Z6,
PAN No.: AAVPW8746Q
TIN No.: 0682132889,
TAN no.: RTKKO3359G
IEC: 0509006116

M: 00 91 9810 291 381, 8800 544 881



OEM Manufacturer & Global Supplier of
Lockout Tagout & Safety Products

to meet
OSHA'S Lockout Tagout Standard
29 CFR, 1910.147&1910.269



www.lockouttagouts.com



GSTIN No.: 06AAECK2831L1Z1
PAN No.: AAECK2831L
TIN No.: 06824000112
CIN No.: U31903HR2011PTC042508
IEC: AAECK2831L

Telefax: 00 91 129 4021 381, 413 1381 (D)

Regd. Office: 1H/31-A, N.I.T, Faridabad-121001 (Haryana) Postal Office: 615, Sector-15-A, Faridabad-121007-Haryana-NCR-INDIA

www.krmcorporation.com | www.lockouttagouts.com | www.krmloto.com | www.locktagindia.com | www.lotoappliances.com



CE
Certified

CIRCUIT BREAKER LOCKOUT



- **Material** – Made of Polycarbonate
- Durable and are quick and easy to apply.
- Circuit Breaker Lockout is designed to fit slightly larger breakers.
- Can be used for double pole circuit breakers lockout application.
- **Color** – Standard color red or it can make as per the quantity required quantity.
- **Weight** – 30gm

KRM-K-CBL-1

MODELS	HEIGHT	WIDTH	DEPTH	HOLE DIA
KRM-K-CBL-1	48mm	60mm	33mm	8mm

KRM CORPORATION

ISO QMS - 9001:2015, ISO EMS 14001:2015, ISO OHSMS 45001:2018
to meet OSHA's Lockout Tagout Standard 29 CFR, 1910.147&1910.269

KRM Safetech Private Limited

QUALITY MANAGEMENT SYSTEM ISO QMS 9001:2015
info@krmcorporation.com, info@krmloto.com, krmloto@gmail.com, wadhwrajinder@gmail.com

M: 00 91 9810 291 381, 8800 544 881, T: 00 91 129 - 4021 381

Postal Add: 615, Sector-15A, Faridabad-121007
Regd. Office: 1H/31A, N.I.T. Faridabad-121001 Haryana - NCR (INDIA)

www.krmloto.com www.krmcorporation.com, www.safetyloto.com
www.lotoappliances.com, www.lockouttagouts.com

GSTIN No.: 06AAMPW8746Q126,
PAN No.: AAVPW8746Q
TIN No.: 06821328889,
TAN no.: RTKKO3359G
IEC: 0509006116

M: 00 91 9810 291 381, 8900 544 881



OEM Manufacturer & Global Supplier of
Lockout Tagout & Safety Products

to meet
OSHA'S Lockout Tagout Standard
29 CFR, 1910.147&1910.269



www.lotoappliances.com



GSTIN No.: 06AAECK2831L1Z1
PAN No.: AAECK2831L
TIN No.: 06824000112
CIN No.: U31903HR2011PTC042508
IEC: AAECK2831L

Telefax: 00 91 129 4021 381, 413 1381 (D)

www.krmcorporation.com | www.lockouttagouts.com | www.krmloto.com | www.locktagindia.com | www.lotoappliances.com

KRM LOTO – CIRCUIT BREAKER LOCKOUT

- **Material** - Made of Polycarbonate
- Durable and are quick and easy to apply.
- Circuit Breaker Lockout is designed to fit almost all type of single pole breakers.
- **Size** – Height-21mm X Width- 56mm X Depth- 28mm
- Used for Circuit Breaker of 120v
- **Color** - Standard color red or it can make as per the required quantity.
- Weight – 20gm



KRM-K-CBL-2

MODELS	HEIGHT	WIDTH	DEPTH	HOLE DIA
KRM-K-CBL-2	21 mm	58 mm	30 mm	7.5 mm

KRM CORPORATION
 ISO 9001:2015, ISO EMS 14001:2015, ISO 45001:2018
 GSTIN No.: 06AAVPW8746Q1Z6,
 PAN No.: AAVPW8746Q
 TIN No.: 06821328889,
 TAN no.: RTKKO3359G
 IEC: 0509006116



KRM LOTO
Lock Tag!
 OEM Manufacturer & Global Supplier of
 Lockout Tagout & Safety Products
 to meet
 OSHA'S Lockout Tagout Standard
 29 CFR, 1910.147&1910.269



KRM Safetech Private Limited
 QUALITY MANAGEMENT SYSTEM ISO QMS 9001:2015
 GSTIN No.: 06AAECK2831L1Z1
 PAN No.: AAECK2831L
 TIN No.: 06824000112
 CIN No.: U31903HR2011PTC042508
 IEC: AAECK2831L

M: 00 91 9810 291 381, 8800 544 881

Email: info@krmloto.com, info@krmcorporation.com, krmloto@gmail.com

Regd. Office: 1H/31-A, N.I.T, Faridabad-121001 (Haryana) Postal Office: 615, Sector-15-A, Faridabad-121007-Haryana-NCR-INDIA

Telefax: 00 91 129 4021 381, 413 1381 (D)

www.krmcorporation.com | www.lockouttagouts.com | www.krmloto.com | www.locktagindia.com | www.lotoappliances.com



KRM LOTO
 SAFETY PRODUCTS
safe loto

CIRCUIT BREAKER LOCKOUT

CE Certified



- **Material** – Made of Polycarbonate
- Durable and are quick and easy to apply.
- Circuit Breaker Lockout is designed to fit almost all type of single pole breakers.
- **Size** – Height-21mm X Width- 56mm X Depth-28mm
- Used for Circuit Breaker of 120V
- **Color** – Standard color red or it can make as per the required quantity.
- **Weight** – 20gm

KRM-K-CBL-2

MODELS	HEIGHT	WIDTH	DEPTH	HOLE DIA
KRM-K-CBL-2	21mm	58mm	30mm	7.5mm



KRM CORPORATION
 ISO QMS - 9001:2015, ISO EMS 14001:2015, ISO 45001:2018
 to meet OSHA'S Lockout Tagout Standard 29 CFR, 1910.147&1910.269

KRM Safetech Private Limited
 QUALITY MANAGEMENT SYSTEM ISO QMS 9001:2015
 info@krmcorporation.com, info@krmloto.com, krmloto@gmail.com, wadhwrajinder@gmail.com

M: 00 91 9810 291 381, 8800 544 881, T: 00 91 129 - 4021 381

Postal Add: 615, Sector-15A, Faridabad-121007 Haryana - NCR (INDIA)
 Regd. Office: 1H/31A, N.I.T. Faridabad-121001

www.krmloto.com www.krmcorporation.com, www.safetyloto.com
 www.lotoappliances.com, www.lockouttagouts.com



OEM Manufacturer & Global Supplier of
 Lockout Tagout & Safety Products

to meet
 OSHA'S Lockout Tagout Standard
 29 CFR, 1910.147&1910.269

www.lockouttagouts.com
 Email: info@krmloto.com, info@krmcorporation.com, krmloto@gmail.com

Regd. Office:1H/31-A, N.I.T, Faridabad-121001 (Haryana) Postal Office:615, Sector-15-A, Faridabad-121007-Haryana-NCR-INDIA

www.krmcorporation.com | www.lockouttagouts.com | www.krmloto.com | www.locktagindia.com | www.lotoappliances.com

KRM LOTO – CIRCUIT BREAKER LOCKOUT – MULTI POLE

LOCKOUT/TAGOUT

- **Material** – Made of Polycarbonate
- It's Durable and are quick and easy to apply.
- Circuit Breaker Lockout is designed to fit multi-pole breakers.
- Used for Circuit Breaker of 120/277V
- **Color** – Standard color red or it can make as per the required quantity.
- **Weight** – 30gm



KRM-K-CBL-4

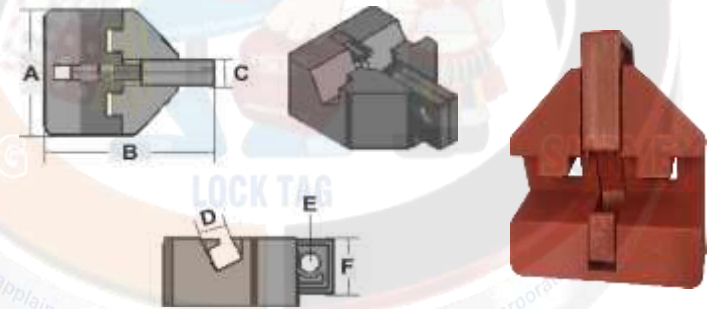

A	B	C	D	E	F
47.5mm	64.9mm	10.6mm	10.6mm	7.5mm	20.7mm



OEM Manufacturer & Global Supplier of
Lockout Tagout & Safety Products

to meet
OSHA'S Lockout Tagout Standard
29 CFR, 1910.147&1910.269



www.lotoappliances.com



Regd. Office: 1H/31-A, N.I.T, Faridabad-121001 (Haryana) | Postal Office: 615, Sector-15-A, Faridabad-121007-Haryana-NCR-INDIA

www.krmcorporation.com | www.lockouttagouts.com | www.krmloto.com | www.locktagindia.com | www.lotoappliances.com



CIRCUIT BREAKER LOCKOUT – MULTI POLE

CE Certified

- **Material** – Made of Polycarbonate
- It's Durable and are quick and easy to apply.
- Circuit Breaker Lockout is designed to fit multi-pole breakers.
- Used for Circuit Breaker of 120/277V
- **Color** – Standard color red or it can make as per the required quantity.
- **Weight** – 30gm

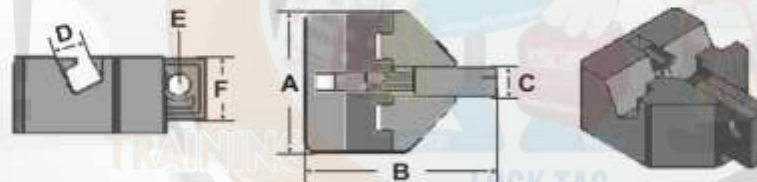

A	B	C	D	E	F
47.5mm	64.9mm	10.6mm	10.6mm	7.5mm	20.7mm

KRM-K-CBL-4

GSTIN No.: 06AAVPW8746Q1Z6,
PAN No.: AAVPW8746Q
TIN No.: 06821328889,
TAN no.: RTKKO3359G
IEC: 0509006116

M: 00 91 9810 291 381, 8900 544 881



OEM Manufacturer & Global Supplier of
Lockout Tagout & Safety Products

to meet
OSHA'S Lockout Tagout Standard
29 CFR, 1910.147&1910.269

www.lockouttagouts.com

Email: info@krmloto.com, info@krmcorporation.com, krmloto@gmail.com

Regd. Office: 1H/31-A, N.I.T, Faridabad-121001 (Haryana) Postal Office: 615, Sector-15-A, Faridabad-121007-Haryana-NCR-INDIA

www.krmcorporation.com

www.lockouttagouts.com

www.krmloto.com

www.locktagindia.com

www.lotoappliances.com

GSTIN No.: 06AAECK2831L1Z1
PAN No.: AAECK2831L
TIN No.: 06824000112
CIN No.: U31903HR2011PTC042508
IEC: AAECK2831L

Telefax: 00 91 129 4021 381, 413 1381 (D)

KRM LOTO – MCB TOGGLE LOTO DEVICE

LOCKOUT/TAGOUT

- **Material** - made of aluminum alloy.
- Suitable for small size circuit breaker
- Can be placed on a small screw driver to loosen the screw and then fit circuit breaker lockout on the MCB and tighten the screw.
- Once done place the padlock to complete lockout.
- Put padlock insert with or without tag after tight the screw.
- **Dimension** – Height- 25mm width-20mm, depth-6mm ,
- **Hole dia** – 8mm
- **Weight** – 10gm
- **Color** – Gold



KRM-K-MTLD



OEM Manufacturer & Global Supplier of
Lockout Tagout & Safety Products

to meet
OSHA'S Lockout Tagout Standard
29 CFR, 1910.147&1910.269



www.locktagindia.com



Regd. Office: 1H/31-A, N.I.T, Faridabad-121001 (Haryana) Postal Office: 615, Sector-15-A, Faridabad-121007-Haryana-NCR-INDIA

www.krmcorporation.com | www.lockouttagouts.com | www.krmloto.com | www.locktagindia.com | www.lotoappliances.com



MCB TOGGLE LOTO DEVICE

CE Certified



- **Material** - made of aluminum alloy.
- Suitable for small size circuit breaker
- Can be placed on a small screw driver to loosen the screw and then fit circuit breaker lockout on the MCB and tighten the screw.
- Once done place the padlock to complete lockout.
- Put padlock insert with or without tag after tight the screw.
- **Dimension** – Height- 25mm width-20mm, depth-6mm ,
- **Hole dia** – 8mm
- **Weight** – 10gm
- **Color** – Gold

KRM-K-MTLD

MODELS	HEIGHT	WIDTH	DEPTH	HOLE DIA	WEIGHT
KRM-K-CBLTB-NT	25mm	20mm	6mm	8mm	10gm

GSTIN No.: 06AACPW8746Q1Z6,
PAN No.: AACPW8746Q
TIN No.: 06821328889,
TAN no.: RTKKO3359G
IEC: 0509006116

M: 00 91 9810 291 381, 8900 544 881



OEM Manufacturer & Global Supplier of
Lockout Tagout & Safety Products

to meet
OSHA'S Lockout Tagout Standard
29 CFR, 1910.147&1910.269



www.lotoappliances.com



GSTIN No.: 06AAECK2831L1Z1
PAN No.: AAECK2831L
TIN No.: 06824000112
CIN No.: U31903HR2011PTC042508
IEC: AAECK2831L

Telefax: 00 91 129 4021 381, 413 1381 (D)

Regd. Office:1H/31-A, N.I.T, Faridabad-121001 (Haryana) Postal Office:615, Sector-15-A, Faridabad-121007-Haryana-NCR-INDIA

www.krmcorporation.com | www.lockouttagouts.com | www.krmloto.com | www.locktagindia.com | www.lotoappliances.com

KRM LOTO – WALL SWITCH LOCKOUT

- **Material** – ABS
- KRM LOTO wall switch lockout device is suitable for wall mounted switches.
- The lockout device can be used to lock switches in “Switched On or Off” positions, then apply the lockout by existing screws.
- Useful in magnetic field as it doesn't any metallic part in it, and suitable for the temperature range from -20°C to 80°C
- **Color** – Red or can make any color as per the required quantity.
- **Weight** – 20 gms



KRM-K-WSLD-1

KRM-K-WSLD-2

GSTIN No.: 06AAMPW8746Q1Z6,
PAN No.: AAVPW8746Q
TIN No.: 06821328889,
TAN no.: RTKKO3359G
IEC: 0509006116

M: 00 91 9810 291 381, 8800 544 881

Regd. Office: 1H/31-A, N.I.T, Faridabad-121001 (Haryana) Postal Office: 615, Sector-15-A, Faridabad-121007-Haryana-NCR-INDIA

www.krmcorporation.com | www.lockouttagouts.com | www.krmloto.com | www.locktagindia.com | www.lotoappliances.com



OEM Manufacturer & Global Supplier of
Lockout Tagout & Safety Products

to meet
OSHA'S Lockout Tagout Standard
29 CFR, 1910.147&1910.269

Email: info@krmloto.com, info@krmcorporation.com, krmloto@gmail.com



www.lotoappliances.com



GSTIN No.: 06AAECK2831L1Z1
PAN No.: AAECK2831L
TIN No.: 06824000112
CIN No.: U31903HR2011PTC042508
IEC: AAECK2831L

Telefax: 00 91 129 4021 381, 413 1381 (D)



KRM LOTO
SAFETY PRODUCTS
safe loto

CIRCUIT BREAKER LOCKOUT – MULTI POLE

CE
Certified



KRM-K-WSLD-1



KRM-K-WSLD-2

- Material – ABS
- KRM LOTO wall switch lockout device is suitable for wall mounted switches.
- The lockout device can be used to lock switches in "Switched On or Off" positions, then apply the lockout by existing screws.
- Useful in magnetic field as it doesn't any metallic part in it, and suitable for the temperature range from -20o C to 80o C
- Color – Red or can make any color as per the required quantity.
- Weight – 20 gms

GSTIN No.: 06AAVPW8746Q1Z6,
PAN No.: AAVPW8746Q
TIN No.: 06821328889,
TAN no.: RTKKO3359G
IEC: 0509006116

M: 00 91 9810 291 381, 8900 544 881



OEM Manufacturer & Global Supplier of
Lockout Tagout & Safety Products

to meet
OSHA'S Lockout Tagout Standard
29 CFR, 1910.147&1910.269



www.lockoutappliances.com



GSTIN No.: 06AAECK2831L1Z1
PAN No.: AAECK2831L
TIN No.: 06824000112
CIN No.: U31903HR2011PTC042508
IEC: AAECK2831L

Telefax: 00 91 129 4021 381, 413 1381 (D)

Regd. Office: 1H/31-A, N.I.T, Faridabad-121001 (Haryana) Postal Office: 615, Sector-15-A, Faridabad-121007-Haryana-NCR-INDIA

www.krmcorporation.com | www.lockouttagouts.com | www.krmloto.com | www.locktagindia.com | www.lotoappliances.com

KRM LOTO – MULTIFUNCTION CIRCUIT BREAKER LOCKOUT WITH FOLDABLE SCREW

- Multifunction circuit Breaker lockout is a versatile device fits on wide range of single, double, triple and four pole of electrical circuit breaker can be accommodates up to one lock and with the help of hasp lockout device can be used for group isolation.
- **Material** – High quality ABS with metallic nut
- KRM Multifunction Circuit Breaker Lockouts will lockout most type of breaker's lever. One size fits in all type of circuit breakers which is UV resistant and suitable for single, double, triple and four pole circuit breaker can be locked with single padlock and lockout hasp.
- Specialty of this lockout is that folding screw is there so that no extra tool required for any assistance.
- **Size** – Length 47 mm, Width 35 mm, Locking Hole diameter 8 mm, Thickness of knob on which it can be installed is
- **Color** – Red or can make any color as per the required quantity.

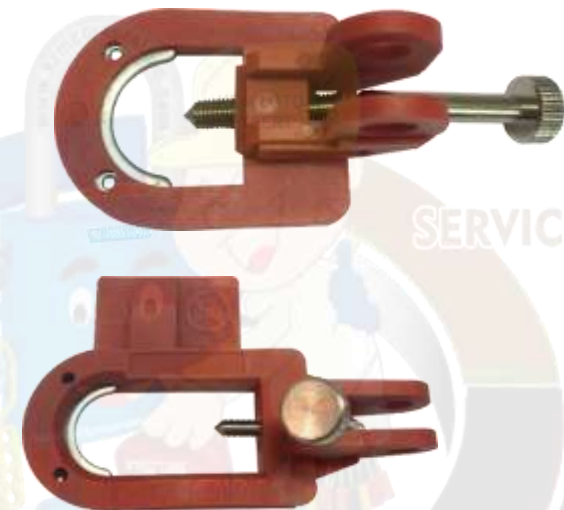

GSTIN No.: 06AAVPW8746Q1Z6,
PAN No.: AAVPW8746Q
TIN No.: 06821328889,
TAN no.: RTKKO3359G
IEC: 0509006116

M: 00 91 9810 291 381, 8800 544 881

**Lock Tag!!**

to meet
OSHA'S Lockout Tagout Standard
29 CFR, 1910.147 & 1910.269



www.lotoappliances.com

safe loto

GSTIN No.: 06AAECK2831L1Z1
PAN No.: AAECK2831L
TIN No.: 06824000112
CIN No.: U31903HR2011PTC042508
IEC: AAECK2831L

Telefax: 00 91 129 4021 381, 413 1381 (D)

Regd. Office: 1H/31-A, N.I.T, Faridabad-121001 (Haryana) Postal Office: 615, Sector-15-A, Faridabad-121007-Haryana-NCR-INDIA

www.krmcorporation.com | www.lockouttagouts.com | www.krmloto.com | www.locktagindia.com | www.lotoappliances.com

Notes:

- Lock & Tag should be used with all loto products.
- For group locking on particular energy hasp should be used.
- Group lockout box should be used for group lockout tagout.
- Scissor Cable or Round cable lockout can be used to lock multiple hazardous energies instead putting individual locks & tags.