

OEM Manufacturer & Global Supplier of
Lockout Tagout & Safety Products

to meet
OSHA'S Lockout Tagout Standard
29 CFR, 1910.147&1910.269

www.lotoappliances.com

Email: info@krmloto.com, info@krmcorporation.com, krmloto@gmail.com

Regd. Office:1H/31-A, N.I.T, Faridabad-121001 (Haryana) Postal Office:615, Sector-15-A, Faridabad-121007-Haryana-NCR-INDIA

www.krmcorporation.com | www.lockouttagouts.com | www.krmloto.com | www.locktagindia.com | www.lotoappliances.com

KRM LOTO METAL LOCKOUT HASP





OEM Manufacturer & Global Supplier of
Lockout Tagout & Safety Products

to meet
OSHA'S Lockout Tagout Standard
29 CFR, 1910.147&1910.269



www.locktagindia.com



Regd. Office:1H/31-A, N.I.T, Faridabad-121001 (Haryana) Postal Office:615, Sector-15-A, Faridabad-121007-Haryana-NCR-INDIA

www.krmcorporation.com | www.lockouttagouts.com | www.krmloto.com | www.locktagindia.com | www.lotoappliances.com

KRM LOTO METAL LOCKOUT HASP

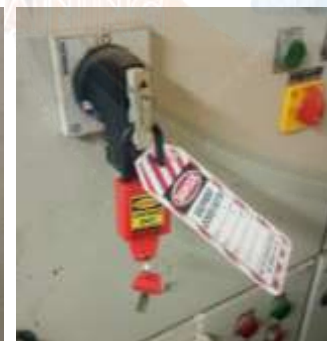



KRM LOTO - LOCKOUT HASP METAL- INDEX

Index Page No:-3

SR.NO	KRM LOTO PART CODE	PRODUCT NAME	WEIGHT (kg)	TECHNICAL PAGE NO.
1	KRM-K-VCH-R-S25	Vinyl Molded coated Hasp - Small - jaw dia -25 mm - RED	0.95	8-9
2	KRM-K-VCH-R-P38/39	Vinyl Molded coated Hasp - Premier -jaw dia -38/39mm - RED	0.105	10-11
3	KRM-K-VCH-SH-S25	KRM LOTO VINYL MOLDED COATED HASP – SINGLE JAW DIA – 25 MM	0.95	12-13
4	KRM-K-VCH-DH-S25	KRM LOTO VINYL MOLDED COATED HASP –DOUBLE HOOK– JAW DIA – 25 MM	0.1	12-13
5	KRM-K-VCH-SH-P38/39	KRM LOTO VINYL MOLDED COATED HASP – SINGLE/ JAW DIA–38/39MM	0.1	14-15
6	KRM-K-VCH-DH-P38/39	KRM LOTO VINYL MOLDED COATED HASP / DOUBLE HOOK –JAW DIA–38/39MM	0.1	14-15
7	KRM-K-PCH-S25-R	KRM LOTO POWDER COATED HASP – SMALL – JAW DIA – 25 MM	0.08	16-17
8	KRM-K-PCH-S25-BL	Powder coated Hasp - Small - Black- jaw dia -25 mm	0.08	16-17
9	KRM-K-PCH-P38/39-R	KRM LOTO POWDER COATED HASP – PREMIER – JAW DIA – 38/39 MM	0.08	18-19
10	KRM-K-PCH-P38/39-BL	Powder Coated Hasp- Premier - Black jaw dia -38/39 mm	0.095	18-19

**KRM LOTO - LOCKOUT HASP METAL- INDEX****Index Page No:-4**

11	KRM-K-PCH-S25-R-12	KRM LOTO POWDER COATED HASP WITH 12 HOLES - RED	0.18	20-21
12	KRM-K-PCH-S25-R-24	Powder coated hasp with 24 holes - Red	0.250	22-23
13	KRM-K-EPH-S25	KRM LOTO ELECTROPLATED HASP – SMALL - JAW DIA - 25 MM	0..08	24-25
14	KRM-K-EPH-P38	Electroplated Hasp - Premier - jaw dia 38/39 mm	0..95	26-27
15	KRM-K-LHPC28	KRM LOTO POWDER COATED HASP MADE OF HARDEN STEEL SHEET - JAW DIA -13MM	0.1	28-29
16	KRM-K-LHPC48	KRM LOTO POWDER COATED HASP MADE OF HARDEN STEEL SHEET - JAW DIA - 25MM	0.1	30-31
17	KRM-K-LHOCG	LOCKOUT OCTA HASP HAVING 6-8 HOLES LOCK HOLES.	0.4	32-33
18	KRM-K-LTOGH	KRM LOTO LOCKOUT TOGGLE HASP	0.1	34-35
19	KRM-K-HDH-S	KRM LOTO HEAVY DUTY METALIC HASP - STEEL MATERIAL - COLOR SILVER - INSIDE JAW DIA - 1" , SHACKLE -60-83MM	0.1	36-37
20	KRM-K-HDH-P	KRM LOTO HEAVY DUTY METALIC HASP - STEEL MATERIAL - COLOR SILVER - INSIDE JAW DIA - 1" , SHACKLE - 60-168MM	0.135	38-39
21	KRM-K-SST	KRM LOTO STAINLESS STEEL HASP – WITHOUT ANY CHAIN	0.1	40-41

OEM Manufacturer & Global Supplier of
Lockout Tagout & Safety Productsto meet
OSHA'S Lockout Tagout Standard
29 CFR, 1910.147&1910.269

www.lockoutappliances.com



KRM LOTO - LOCKOUT HASP METAL- INDEX

Index Page No:-5

22	KRM-K-SST-Y	Stainless steel hasp Yellow -without any chain Color - Yellow	0.1	42-43
23	KRM-K-SPH2	KRM LOTO PLASTIC BODY LOCKOUT HASP HAVING 2 HOLES TO ACCOMMODATE THE PADLOCKS AND CAN ADD MORE LOCK WITH ADDITION HASP	0.125	44-45
24	KRM-K-MDJH8	KRM LOTO METAL DUAL JAW LOCKOUT HASP WITH CHROME FINISH - JAW SIZE 25 MM AND 38 MM WITH 8 HOLES	0.150	46-47
25	KRM-K-MDJH-R8	KRM LOTO METAL DUAL JAW LOCKOUT HASP WITH POWDER COATING RED - JAW SIZE 25 MM AND 38 MM WITH 8 HOLES	0.150	46-47
26	KRM-K-UDJLH	KRM LOTO UNIVERSAL DUAL JAW LOCKOUT HASP - METAL- 6 HOLES	0.110	48-49
28	KRM-K-VCH-SSR-S25	KRM LOTO VINYL MOLDED COATED HASP – STEEL – SMALL - JAW DIA - 25 MM	0..08	50-51
29	KRM-K-VCH-SSR-P-38/39	KRM LOTO VINYL MOLDED COATED HASP – STEEL – SMALL – JAW DIA – 38/39 MM	0..09	52-53
31	KRM-K-AMCH-S25	KRM LOTO ALUMINIUM BASE MOLDED COATED GRIP HASP -SMALL - JAW DIA -25 MM LIGHT WEIGHT - 4COLOR AVAILABLE - R/G/B/Y	0.05	54-55

OEM Manufacturer & Global Supplier of
Lockout Tagout & Safety Productsto meet
OSHA'S Lockout Tagout Standard
29 CFR, 1910.147&1910.269

www.lotoappliances.com



Regd. Office:1H/31-A, N.I.T, Faridabad-121001 (Haryana) Postal Office:615, Sector-15-A, Faridabad-121007-Haryana-NCR-INDIA

www.krmcorporation.com | www.lockouttagouts.com | www.krmloto.com | www.locktagindia.com | www.lotoappliances.com

KRM LOTO - LOCKOUT HASP METAL- INDEX

Index Page No:-6

32	KRM-K-AMCH-P-38/39	KRM LOTO ALUMINUM BASE MOLDED COATED GRIP HASP - PREMIER - JAW DIA 38/39 MM	0.05	56-57
33	KRM-K-ADJH10	KRM LOTO ALUMINIUM DUAL JAW HASP - JAW DIA 25 AND 38 MM WITH 10 HOLES	0.150	58-59
34	KRM-K-ADJH8	KRM LOTO ALUMINIUM DUAL JAW HASP - JAW DIA 25 AND 38 MM WITH 8 HOLES	0.150	60-61
35	KRM-K-AGLH-S-25	KRM LOTO ALUMINUM GROUP LOCKOUT HASP - JAW DIA 25 MM	0.07	62-63
36	KRM-K-AGLH-P-38/39	KRM LOTO ALUMINUM GROUP LOCKOUT HASP - JAW DIA 38 MM	0.08	64-65
37	KRM-K-PAGLH-P-25	KRM LOTO ALUMINUM GROUP LOCKOUT HASPS IN RED COLOR - JAW DIA 25 MM	0.07	66-67
38	KRM-K-PAGLH-P-38/39	KRM LOTO ALUMINUM GROUP LOCKOUT HASPS IN RED COLOR - JAW DIA 25 MM	0.08	68-69
39	KRM-K-LTLH-AL-10	KRM LOTO LABELED HASP - ALUMINIUM BASE SHEET	0.1	70-71
40	KRM-K-LTLH-M-06	KRM LOTO LABELED HASP WITH 6 HOLES - ONE SIDE ONLY - POWDER COATED METAL BASE SHEET	0.1	72-73
41	KRM-K-LTLH-M-8	Labeled hasp with 8 holes - Powder coated metal base sheet	0.1	74-75
42	KRM-K-LTLH-M-10	KRM LOTO LABELED HASP WITH 10 HOLES - POWDER COATED METAL BASE SHEET	0.1	76-77



OEM Manufacturer & Global Supplier of
Lockout Tagout & Safety Products

to meet
OSHA'S Lockout Tagout Standard
29 CFR, 1910.147&1910.269



www.lotoappliances.com



KRM LOTO - LOCKOUT HASP METAL- INDEX

Index Page No:-7

43	KRM-K-LTLH-M-12	KRM LOTO LABELED HASP WITH 12 HOLES - POWDER COATED METAL BASE SHEET	0.1	78-79
44	KRM-K-LTLH-M-14	KRM LOTO LABELED HASP WITH 14 HOLES - POWDER COATED METAL BASE SHEET	0.1	80-81
45	KRM-K-LTLH-M-16	KRM LOTO LABELED HASP WITH 16 HOLES - POWDER COATED METAL BASE SHEET	0.1	82-83
46	KRM-K-LTLHLBL	KRM LOTO WRITABLE LABEL ONLY FOR LABELED HASP	0.1	84-85





OEM Manufacturer & Global Supplier of
 Lockout Tagout & Safety Products

to meet
 OSHA'S Lockout Tagout Standard
 29 CFR, 1910.147&1910.269



www.locktagindia.com



KRM LOTO VINYL MOLDED COATED HASP - SMALL - JAW DIA - 25 MM

- Manufacture of – Hardened metal steel with highly visible vinyl molded grip used for maintenance and prevention of power devices, available with 6 holes designed to provide protection on various installed device to meet OSHAS Lockout / Tagout Standard, 29 CFR & 1910.147 & 1910.269
- **Material** – Hardened metal steel with Vinyl molded coated on grip.
- KRM LOTO Vinyl molded coated Hasp is used to lock the device in OFF position OR permanent ON position accepts to six locks for group Isolation with di-energized insulated grip. Available in two different sizes small and premier.
- **Dimension** – Jaw diameter 25 mm for small hasp
- **Height** – 113 mm
- **Weight** – 90 gm
- **Holes** – 6
- **Color** – Red Or any color make as per the required quantity



KRM-K-VCH-R-S-25

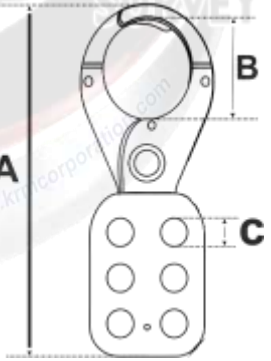

ITEM CODE	HEIGHT (A)	JAW SIZE DIA (B)	PADLOCK HOLE DIA (C)	NO OF HOLES	WEIGHT
KRM-K-VCH-R-S-25	113 mm	25 mm	9 mm	6	90 gms



OEM Manufacturer & Global Supplier of
Lockout Tagout & Safety Products

to meet
OSHA'S Lockout Tagout Standard
29 CFR, 1910.147&1910.269



www.locktagindia.com



LOCKOUT/TAGOUT

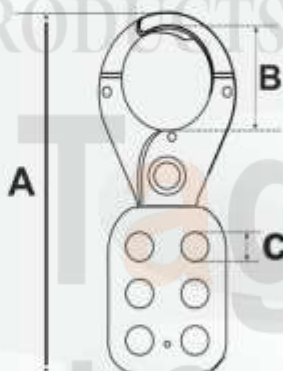

KRM-K-VCH-R-S-25

VINYL MOLDED COATED LOCKOUT HASP - SMALL - JAW DIA - 25 MM

KRM LOTO
EXP
CE Certified

Manufacture of hardened metal steel with highly visible vinyl molded grip used for maintenance and prevention of power devices, available with 6 holes designed to provide protection on various installed device to meet OSHAS Lockout / Tagout Standard, 29 CFR & 1910.147 & 1910.269

- **Material** – Hardened Metal Steel with Vinyl molded coated on grip
- KRM LOTO Vinyl molded coated Hasp is used to lock the device in OFF position OR permanent ON position accepts up to six locks for group isolation with de energized insulated grip. Available in two different sizes small and premier.
- **Dimension** – Jaw diameter 25 mm for small hasp
- **Height** – 113 mm
- **Weight** – 90 gm
- **No. of Holes** – 6
- **Color** – Red Or any color make as per the required quantity.



KRM-K-VCH-S25

ITEM CODE	Height (A)	Jaw Size Dia (B)	Padlock Hole Dia (C)	No.Of Holes	WEIGHT
KRM-K-VCH-R-S-25	113mm	25mm	9 mm	6	90gms



KRM LOTO VINYL MOLDED COATED HASP - PREMIER - JAW DIA – 38/39 MM

- Manufacture of – Hardened metal steel with highly visible vinyl molded grip used for maintenance and prevention of power devices, available with 6 holes designed to provide protection on various installed device to meet OSHAS Lockout / Tagout Standard, 29 CFR & 1910.147 & 1910.269
- **Material** – hardened metal steel with Vinyl molded coated on grip
- KRM LOTO Vinyl molded coated Hasp is used to lock the device in OFF position OR permanent ON position accepts up to six locks for group Isolation with di-energized insulated grip. Available in two different sizes small and premier.
- **Dimension** – Jaw diameter 38 mm
- Height – 128 mm
- **Weight** – 100 gm
- **Holes** – 6
- **Color** – Red Or any color make as per the required quantity

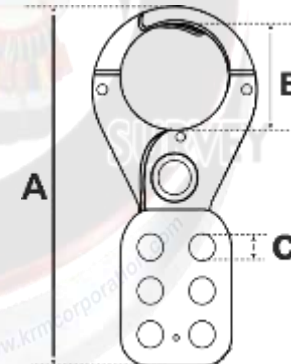
**KRM-K-VCH-R-P-38/39**

ITEM CODE	HEIGHT (A)	JAW SIZE DIA (B)	PADLOCK HOLE DIA (C)	NO OF HOLES	WEIGHT
KRM-K-VCH-R-P-38/39	128 mm	38 mm	9 mm	6	100 gms



OEM Manufacturer & Global Supplier of
Lockout Tagout & Safety Products

to meet
OSHA'S Lockout Tagout Standard
29 CFR, 1910.147&1910.269



www.locktagindia.com



LOCKOUT/TAGOUT



VINYL MOLDED COATED LOCKOUT HASP - PREMIER - JAW DIA - 38/39 MM

CE Certified

Manufacture of hardened metal steel with highly visible vinyl molded grip used for maintenance and prevention of power devices, available with 6 holes designed to provide protection on various installed device to meet OSHAS Lockout / Tagout Standard, 29 CFR & 1910.147 & 1910.269

- **Material** – Hardened Metal Steel with Vinyl molded coated on grip
- KRM LOTO Vinyl molded coated Hasp is used to lock the device in OFF position OR permanent ON position accepts up to six locks for group isolation with de energized insulated grip. Available in two different sizes small and premier.
- **Dimension** – Jaw diameter 38 mm
- **Height** – 128 mm
- **Weight** – 100 gm
- **No. of Holes** – 6
- **Color** – Red Or any color make as per the required quantity



KRM-K-VCH-R-P-38/39

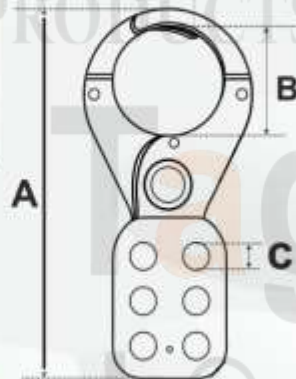

KRM-K-VCH-P-38/39

ITEM CODE	Height (A)	Jaw Size Dia (B)	Padlock HoleDia (C)	No.Of Holes	WEIGHT
KRM-K-VCH-R-P-38/39	128mm	38mm	9 mm	6	100gm



OEM Manufacturer & Global Supplier of
 Lockout Tagout & Safety Products

to meet
 OSHA'S Lockout Tagout Standard
 29 CFR, 1910.147&1910.269



www.locktagindia.com



KRM LOTO VINYL MOLDED COATED HASP – SINGLE/ DOUBLE HOOK LOCKOUT HASP – JAW DIA – 25 MM

- **Material** – Hardened metal steel with Vinyl coated at grip
- KRM LOTO Vinyl coated Hasp is used to lock the device in OFF position Or permanent ON position accepts up to six padlocks for group Isolation with di-energized insulated grip. Available in two different sizes small and premier. Equipped with single / double locking hook for better gripping at the locked equipment
- **Dimension** – Jaw diameter 25 mm for small hasp with height 113 mm
- **Weight** – 95 gm
- **Holes** – 6
- **Color** – Red, Yellow, Green and Blue or any color make as per the required quantity



KRM-K-VCH-SH-S25



KRM-K-VCH-DH-S25

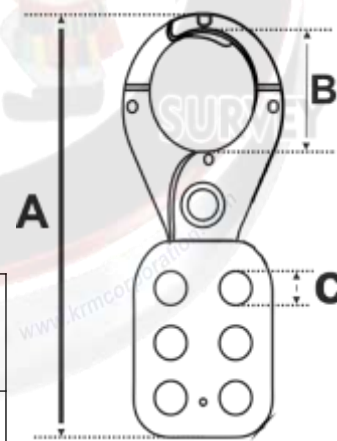

ITEM CODE	OUTER LENGTH (A)	JAW SIZE DIA (B)	PADLOCK HOLE DIA (C)	NO OF HOLES	WEIGHT
KRM-K-VCH-SH-R-S-25	113 mm	25 mm	9 mm	6	95 gms
KRM-K-VCH-DH-R-S-25					



OEM Manufacturer & Global Supplier of
Lockout Tagout & Safety Products

to meet
OSHA'S Lockout Tagout Standard
29 CFR, 1910.147&1910.269

www.lockouttagouts.com



LOCKOUT/TAGOUT



**VINYL MOLDED COATED LOCKOUT HASP
- SINGLE/ DOUBLE HOOK**

KRM LOTO
EXPERT
CE
Certified

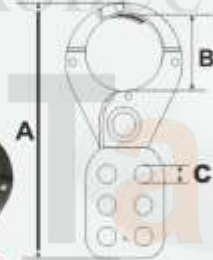

KRM-K-VCH-SH-S-25 KRM-K-VCH-DH-P38/39

- Material – Hardened Metal Steel with Vinyl coated at grip
- KRM LOTO Vinyl coated Hasp is used to lock the device in OFF position Or permanent ON position accepts up to six padlocks for group Isolation with di-energized insulated grip. Available in two different sizes small and premier.
- Equipped with single / double locking hook for better gripping at the locked equipment
- **Dimension** – Jaw diameter 25 mm for small hasp with height 113 mm Jaw diameter 38/39 mm for premier hasp with height 128 mm
- **Weight** – 95 gm for small hasp and 110 gm for premier hasp with single hook, 100 gm for small hasp and 115 gm for premier hasp with double hook
- **No. of Holes** – 6
- **Color** – Red, Yellow, Green and Blue or any color make as per the required quantity



Item Code	Height (A)	Jaw Size Dia (B)	Padlock HoleDia (C)	No.Of Holes	Weight
KRM-K-VCH-DH S25 KRM-K-VCH-SH S25	113mm	25mm	09mm	6	95gm
KRM-K-VCH-DH P38/39 KRM-K-VCH-SH P38/39	128mm	38mm	09mm	6	110gm



OEM Manufacturer & Global Supplier of
 Lockout Tagout & Safety Products

to meet
 OSHA'S Lockout Tagout Standard
 29 CFR, 1910.147&1910.269



www.lockouttagouts.com



KRM LOTO VINYL MOLDED COATED HASP – SINGLE/ DOUBLE HOOK LOCKOUT HASP–JAW DIA–38/39MM

- Material – Hardened Metal Steel with Vinyl coated at grip
- KRM LOTO Vinyl coated Hasp is used to lock the device in OFF position Or permanent ON position accepts up to six padlocks for group Isolation with di-energized insulated grip. Available in two different sizes small and premier.
- Equipped with single / double locking hook for better gripping at the locked equipment
- **Dimension** – Jaw diameter 25 mm for small hasp with height 113 mm Jaw diameter 38/39 mm for premier hasp with height 128 mm
- **Weight** – 95 gm for small hasp and 110 gm for premier hasp with single hook,
- 100 gm for small hasp and 115 gm for premier hasp with double hook
- **No. of Holes** – 6
- **Color** – Red, Yellow, Green and Blue or any color make as per the required quantity



KRM-K-VCH-SH-P-38/39



KRM-K-VCH-DH-P-38/39

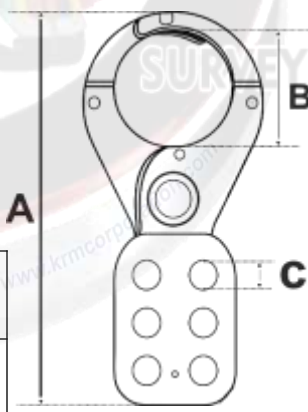

ITEM CODE	HEIGHT (A)	JAW SIZE DIA (B)	PADLOCK HOLE DIA (C)	NO OF HOLES	WEIGHT
KRM-K-VCH-SH-P-38/39 KRM-K-VCH-DH-P-38/39	128 mm	38 mm	9 mm	6	110 gms



OEM Manufacturer & Global Supplier of
Lockout Tagout & Safety Products

to meet
OSHA'S Lockout Tagout Standard
29 CFR, 1910.147&1910.269



www.lockoutappliances.com



LOCKOUT/TAGOUT



KRM LOTO
EXPERT
CE
Certified

**VINYL MOLDED COATED LOCKOUT HASP
- SINGLE/ DOUBLE HOOK**

- Material – Hardened Metal Steel with Vinyl coated at grip
- KRM LOTO Vinyl coated Hasp is used to lock the device in OFF position Or permanent ON position accepts up to six padlocks for group Isolation with di-energized insulated grip. Available in two different sizes small and premier.
- Equipped with single / double locking hook for better gripping at the locked equipment
- **Dimension** – Jaw diameter 25 mm for small hasp with height 113 mm Jaw diameter 38/39 mm for premier hasp with height 128 mm
- **Weight** – 95 gm for small hasp and 110 gm for premier hasp with single hook, 100 gm for small hasp and 115 gm for premier hasp with double hook
- **No. of Holes** – 6
- **Color** – Red, Yellow, Green and Blue or any color make as per the required quantity

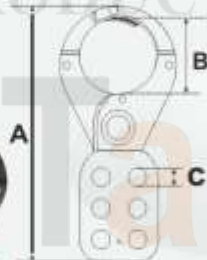

KRM-K-VCH-SH-S-25 KRM-K-VCH-DH-P38/39



Item Code	Height (A)	Jaw Size Dia (B)	Padlock Hole Dia (C)	No.Of Holes	Weight
KRM-K-VCH-DH S25 KRM-K-VCH-SH S25	113mm	25mm	09mm	6	95gm
KRM-K-VCH-DH P38/39 KRM-K-VCH-SH P38/39	128mm	38mm	09mm	6	110gm



OEM Manufacturer & Global Supplier of
 Lockout Tagout & Safety Products

to meet
 OSHA'S Lockout Tagout Standard
 29 CFR, 1910.147&1910.269



www.locktagindia.com



KRM LOTO POWDER COATED HASP – SMALL – JAW DIA – 25 MM

- **Material** – Hardened metal steel with fully Powder coated .
- KRM LOTO powder coated Hasp is used to Isolate the Electrical device for group locking, six people can lock the device at a time and can be used on all type of power switches, it's tamper steel , insulation resin and flame proof resin.
- **Dimension** – Jaw diameter 25 mm for small hasp Height - 113 mm.
- **Weight** – 80 gm
- **Holes** – 6
- **Color** – Red, Black or any color make as per the required quantity



KRM-K-PCH-S25-R



KRM-K-PCH-S25-BL

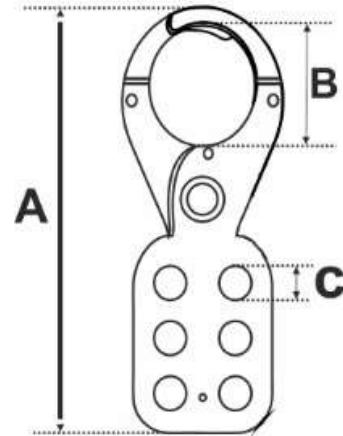

ITEM CODE	HEIGHT (A)	JAW SIZE DIA (B)	HOLE SIZE (C)	NO OF HOLES	WEIGHT
KRM-K-PCH-S-25 KRM-K-PCH-S-BL	113 mm	25 mm	11 mm	6	80 gms



OEM Manufacturer & Global Supplier of
Lockout Tagout & Safety Products

to meet
OSHA'S Lockout Tagout Standard
29 CFR, 1910.147&1910.269



www.locktagindia.com



LOCKOUT/TAGOUT



POWDER COATED LOCKOUT HASP

KRM LOTO
EXPERT

CE
Certified



- **Material** – Hardened Metal Steel with fully Powder coated
- KRM LOTO powder coated Hasp is used to Isolate the Electrical device for group locking, six people can lock the device at a time and can be used on all type of power switches, it's tamper steel , insulation resin and flame proof resin.
- **Dimension** – Jaw diameter 25 mm for small hasp with height 113 mm
Jaw diameter 38/39 mm for premier hasp with height 128 mm
- **Weight** – 80 gm for small hasp & 90 gm for premier hasp
- **No. of Holes** – 6
- **Color** – Red, Black or any color make as per the required quantity

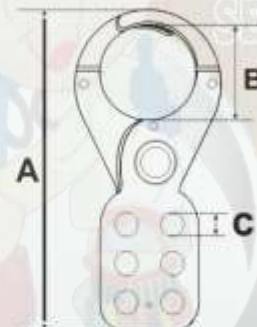

KRM-K-PCH-S-25-R/BL

KRM-K-PCH-P-38/39-R/BL

Item Code	Height (A)	Jaw Size Dia (B)	Hole Size (C)	No.of Holes	Weight
KRM-K-PCH-S-25-R KRM-K-PCH-S25-BL	113mm	25mm	11mm	6	80gm
KRM-K-PCH-P-38/39-R KRM-K-PCH-P-38/39-BL	128mm	38/39mm	11mm	6	90gm



OEM Manufacturer & Global Supplier of
 Lockout Tagout & Safety Products

to meet
 OSHA'S Lockout Tagout Standard
 29 CFR, 1910.147&1910.269



KRM LOTO POWDER COATED HASP – PREMIER – JAW DIA – 38/39 MM

- **Material** –Hardened metal steel with fully Powder coated
- KRM LOTO powder coated Hasp is used to Isolate the Electrical device for group locking, six people can lock the device at a time and can be used on all type of power switches, it's tamper steel , insulation resin and flame proof resin.
- **Dimension** – Jaw diameter 38/39 mm for premier hasp with height - 128 mm
- **Weight** – 100 gm
- **Holes** – 6
- **Color** – Red, Black or any color make as per the required quantity



KRM-K-PCH-P38/39-R



KRM-K-PCHP38/39-BL

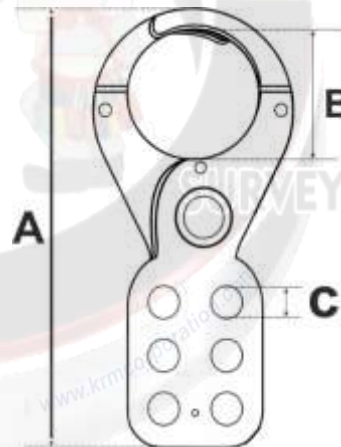

ITEM CODE	OUTER LENGTH (A)	JAW SIZE DIA (B)	HOLE SIZE (C)	NO OF HOLES	WEIGHT
KRM-K-PCH-P-38/39 KRM-K-PCH-P-38/39	128 mm	38/39 mm	11 mm	6	90 gms

GSTIN No.: 06AAVPW8746Q1Z6,
PAN No.: AAVPW8746Q
TIN No.: 06821328889,
TAN no.: RTKKO3359G
IEC: 0509006116

M: 00 91 9810 291 381, 8800 544 881

Regd. Office: 1H/31-A, N.I.T, Faridabad-121001 (Haryana) Postal Office: 615, Sector-15-A, Faridabad-121007-Haryana-NCR-INDIA

www.krmcorporation.com | www.lockouttagouts.com | www.krmloto.com | www.locktagindia.com | www.lotoappliances.com



OEM Manufacturer & Global Supplier of
Lockout Tagout & Safety Products

to meet
OSHA'S Lockout Tagout Standard
29 CFR, 1910.147&1910.269



www.lotoappliances.com



GSTIN No.: 06AAECK2831L1Z1
PAN No.: AAECK2831L
TIN No.: 06824000112
CIN No.: U31903HR2011PTC042508
IEC: AAECK2831L

Telefax: 00 91 129 4021 381, 413 1381 (D)

LOCKOUT/TAGOUT



POWDER COATED LOCKOUT HASP

KRM LOTO
EXPERT

CE
Certified



- **Material** – Hardened Metal Steel with fully Powder coated
- KRM LOTO powder coated Hasp is used to Isolate the Electrical device for group locking, six people can lock the device at a time and can be used on all type of power switches, it's tamper steel, insulation resin and flame proof resin.
- **Dimension** – Jaw diameter 25 mm for small hasp with height 113 mm
Jaw diameter 38/39 mm for premier hasp with height 128 mm
- **Weight** – 80 gm for small hasp & 90 gm for premier hasp
- **No. of Holes** – 6
- **Color** – Red, Black or any color make as per the required quantity

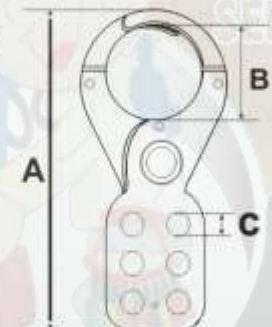

KRM-K-PCH-S-25-R/BL

KRM-K-PCH-P-38/39-R/BL

Item Code	Height (A)	Jaw Size Dia (B)	Hole Size (C)	No. of Holes	Weight
KRM-K-PCH-S-25-R KRM-K-PCH-S-25-BL	113mm	25mm	11mm	6	80gm
KRM-K-PCH-P-38/39-R KRM-K-PCH-P-38/39-BL	128mm	38/39mm	11mm	6	90gm

M: 00 91 9810 291 381, 8800 544 881, T: 00 91 129 - 4021 381

info@krmcorporation.com, info@krmloto.com, krmloto@gmail.com, wadwarajinder@gmail.com

Postal Add: 615, Sector-15A, Faridabad-121007 Haryana - NCR (INDIA)
Regd. Office: 1H/31A, N.I.T. Faridabad-121001

www.krmloto.com www.krmcorporation.com, www.safetyloto.com
www.lotoappliances.com, www.lockouttagouts.com



OEM Manufacturer & Global Supplier of
Lockout Tagout & Safety Products

to meet
OSHA'S Lockout Tagout Standard
29 CFR, 1910.147&1910.269



www.lockoutappliances.com



KRM LOTO POWDER COATED HASP WITH 12 HOLES - RED

- KRM LOTO hardened metal steel with Powder coated Hasp for Group Locking purpose standard design with 12 holes
- **Material** hardened metal steel with Powder Coated
- **Hasp Dia** - 25mm
- **Height** – 160 mm
- **Weight** - 130gms

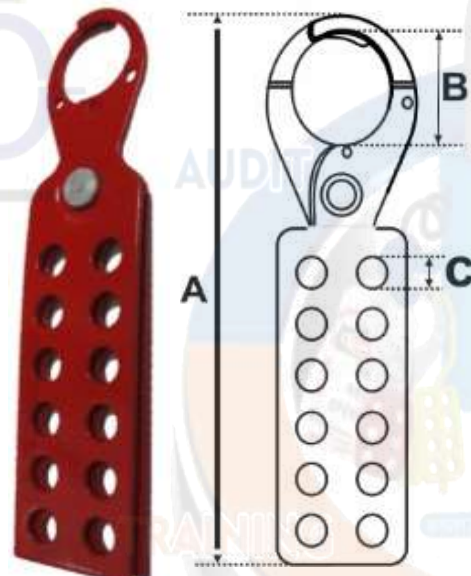

KRM-K-PCH-S25-R-12

ITEM CODE	Height (A)	JAW SIZE DIA(B)	HOLE SIZE (C)	NO OF HOLES	WEIGHT
KRM-K-PCH-S25-R-12	160 mm	25 mm	10 mm	12	130 gms



OEM Manufacturer & Global Supplier of
Lockout Tagout & Safety Products

to meet
OSHA'S Lockout Tagout Standard
29 CFR, 1910.147&1910.269



Regd. Office: 1H/31-A, N.I.T, Faridabad-121001 (Haryana) Postal Office: 615, Sector-15-A, Faridabad-121007-Haryana-NCR-INDIA

www.krmcorporation.com | www.lockouttagouts.com | www.krmloto.com | www.locktagindia.com | www.lotoappliances.com

LOCKOUT/TAGOUT



POWDER COATED LOCKOUT HASP WITH 12 HOLES - RED

CE Certified



KRM-K-PCH-S25-R-12/24

- KRM LOTO Hardened Metal Steel Powder coated Hasp for Group Locking purpose standard design with 12 holes
- **Material** - Hardened Metal Steel with power coated.
- **Hasp Dia** - 25mm
- **Height** – 160 mm for 12 holes hasp & 250 mm for 24 holes hasp
- **Weight** - 130gms for 12 holes hasp & 200 gms for 24 holes hasp

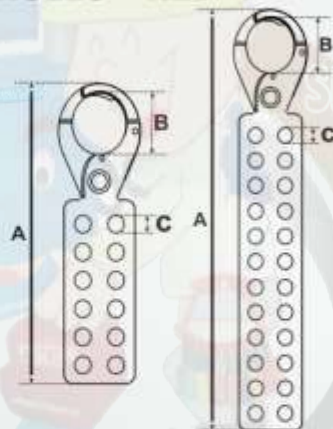

Item Code	Height(A)	Jaw Dia(B)	Hole Size(C)	No.Of Holes	Weight
KRM-K-PCH-S25-R-12	160mm	25mm	10mm	12	130gm
KRM-K-PCH-S25-R-24	250mm	25mm	10mm	24	200gm



OEM Manufacturer & Global Supplier of
 Lockout Tagout & Safety Products

to meet
 OSHA'S Lockout Tagout Standard
 29 CFR, 1910.147&1910.269



www.lotoappliances.com



KRM LOTO POWDER COATED HASP WITH 24 HOLES – RED

- KRM LOTO hardened metal steel with Powder coated Hasp for Group Locking purpose standard design with 24 holes
- **Material** - hardened metal steel with Powder Coated
- **Hasp Dia** - 25mm
- **Height** – 250 mm
- **Weight** – 200 gms

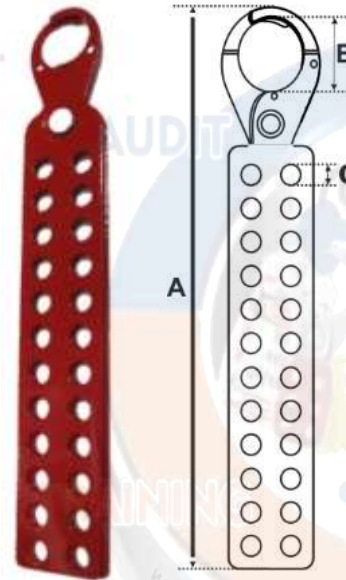

KRM-K-PCH-S25-R-24



ITEM CODE	Height (A)	JAW SIZE DIA (B)	HOLE SIZE (C)	NO OF HOLES	WEIGHT
KRM-K-PCH-S25-R-24	250 mm	25 mm	10 mm	24	200 gms



OEM Manufacturer & Global Supplier of
Lockout Tagout & Safety Products

to meet
OSHA'S Lockout Tagout Standard
29 CFR, 1910.147&1910.269



Regd. Office: 1H/31-A, N.I.T, Faridabad-121001 (Haryana) Postal Office: 615, Sector-15-A, Faridabad-121007-Haryana-NCR-INDIA

www.krmcorporation.com | www.lockouttagouts.com | www.krmloto.com | www.locktagindia.com | www.lotoappliances.com

LOCKOUT/TAGOUT



POWDER COATED LOCKOUT HASP WITH 12 HOLES - RED

CE Certified



- KRM LOTO Hardened Metal Steel Powder coated Hasp for Group Locking purpose standard design with 12 holes
- **Material** - Hardened Metal Steel with power coated.
- **Hasp Dia** - 25mm
- **Height** – 160 mm for 12 holes hasp & 250 mm for 24 holes hasp
- **Weight** - 130gms for 12 holes hasp & 200 gms for 24 holes hasp

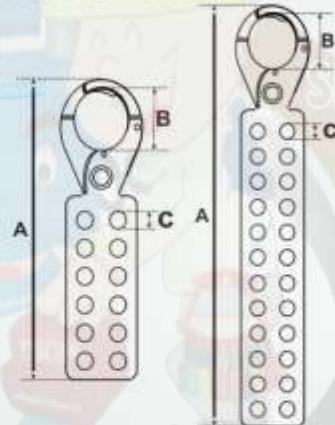

Item Code	Height(A)	Jaw Dia(B)	Hole Size(C)	No.Of Holes	Weight
KRM-K-PCH-525-R-12	160mm	25mm	10mm	12	130gm
KRM-K-PCH-525-R-24	250mm	25mm	10mm	24	200gm

KRM-K-PCH-S25-R-12/24



OEM Manufacturer & Global Supplier of Lockout Tagout & Safety Products

to meet
 OSHA'S Lockout Tagout Standard
 29 CFR, 1910.147&1910.269



www.lotoappliances.com

Email: info@krmloto.com, info@krmcorporation.com, krmloto@gmail.com

Regd. Office: 1H/31-A, N.I.T, Faridabad-121001 (Haryana) Postal Office: 615, Sector-15-A, Faridabad-121007-Haryana-NCR-INDIA

www.krmcorporation.com | www.lockouttagouts.com | www.krmloto.com | www.locktagindia.com | www.lotoappliances.com

KRM LOTO ELECTROPLATED HASP – SMALL - JAW DIA -25 MM

- Material** – hardened metal steel with Electroplated
- KRM LOTO Vinyl coated Hasp is used to Isolate the Electrical device for group locking, six people can lock the device at a time and can be used on all type of power switches, it's tamper steel , insulation resin, flame proof resin.
- Dimension** – Jaw diameter 25 mm for small hasp with height 113 mm
- Weight** – 80 gms
- Holes – 6
- Color** – Silver metallic finish



KRM-K-EPH-S-25

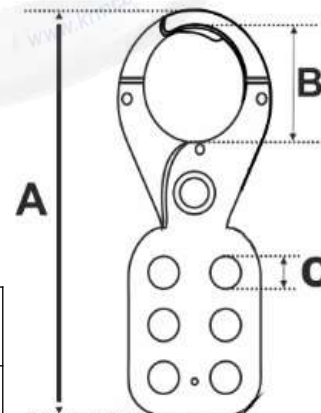

ITEM CODE	HEIGHT (A)	JAW SIZE DIA (B)	HOLE SIZE (C)	NO OF HOLES	WEIGHT
KRM-K-EPH-S-25	113 mm	25 mm	11 mm	6	80 gms



OEM Manufacturer & Global Supplier of
Lockout Tagout & Safety Products

to meet
OSHA'S Lockout Tagout Standard
29 CFR, 1910.147&1910.269



www.lockouttagouts.com



LOCKOUT/TAGOUT



ELECTROPLATED LOCKOUT HASP

KRM LOTO
EXPERT

CE
Certified



KRM-K-EPH-S-25

KRM-K-EPH-P-38/39

- **Material** – Hardened Metal Steel with electroplated
- KRM LOTO Vinyl coated Hasp is used to Isolate the Electrical device for group locking, six people can lock the device at a time and can be used on all type of power switches, it's tamper steel , insulation resin, flame proof resin.
- **Dimension** – Jaw diameter 25 mm for small hasp with height 113 mm
Jaw diameter 38/39 mm for small hasp with height 128 mm
- **No. of Holes** – 6
- **Weight** – 80 gm for small hasp & 90 gm for premier hasp
- **Color** – Silver metallic finish

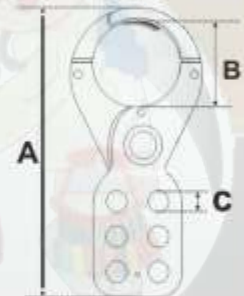

Item Code	Height (A)	Jaw Size Dia (B)	Hole Size (C)	No.of Holes	Weight
KRM-K-EPH-S-25	113mm	25mm	11mm	6	80gm
KRM-K-EPH-P-38/39	128mm	38/39mm	11mm	6	90gm



OEM Manufacturer & Global Supplier of
 Lockout Tagout & Safety Products

to meet
 OSHA'S Lockout Tagout Standard
 29 CFR, 1910.147&1910.269

Email: info@krmloto.com, info@krmcorporation.com, krmloto@gmail.com

Regd. Office: 1H/31-A, N.I.T, Faridabad-121001 (Haryana) Postal Office: 615, Sector-15-A, Faridabad-121007-Haryana-NCR-INDIA

www.krmcorporation.com | www.lockouttagouts.com | www.krmloto.com | www.locktagindia.com | www.lotoappliances.com



KRM LOTO ELECTROPLATED HASP - PREMIER - JAW DIA 38/39MM

- **Material** – hardened metal steel with Electroplated
- KRM LOTO Vinyl coated Hasp is used to Isolate the Electrical device for group locking, six people can lock the device at a time and can be used on all type of power switches, it's tamper steel, insulation resin, flame proof resin.
- **Dimension** – Jaw diameter 38/39 mm for small hasp with height 128 mm
- **Weight** – 90 gms
- Holes – 6
- **Color** – Silver metallic finish



KRM-K-EPH-P38

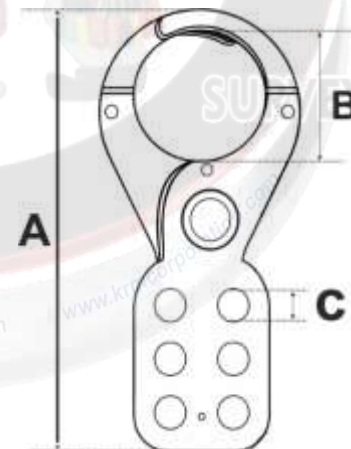

ITEM CODE	HEIGHT (A)	JAW SIZE DIA (B)	HOLE SIZE (C)	NO OF HOLES	WEIGHT
KRM-K-EPH-P 38/39	128 mm	38/39 mm	11 mm	6	90 gms



OEM Manufacturer & Global Supplier of
Lockout Tagout & Safety Products

to meet
OSHA'S Lockout Tagout Standard
29 CFR, 1910.147&1910.269



www.lockouttagouts.com



LOCKOUT/TAGOUT



ELECTROPLATED LOCKOUT HASP

KRM LOTO
EXPERT

CE
Certified



KRM-K-EPH-S-25

KRM-K-EPH-P-38/39

- **Material** – Hardened Metal Steel with electroplated
- KRM LOTO Vinyl coated Hasp is used to Isolate the Electrical device for group locking, six people can lock the device at a time and can be used on all type of power switches, it's tamper steel , insulation resin, flame proof resin.
- **Dimension** – Jaw diameter 25 mm for small hasp with height 113 mm
Jaw diameter 38/39 mm for small hasp with height 128 mm
- **No. of Holes** – 6
- **Weight** – 80 gm for small hasp & 90 gm for premier hasp
- **Color** – Silver metallic finish

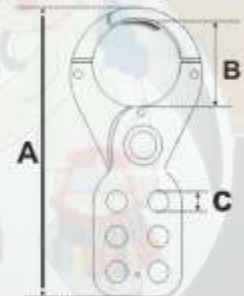

Item Code	Height (A)	Jaw Size Dia (B)	Hole Size (C)	No.of Holes	Weight
KRM-K-EPH-S-25	113mm	25mm	11mm	6	80gm
KRM-K-EPH-P-38/39	128mm	38/39mm	11mm	6	90gm

**KRM LOTO POWDER COATED HASP MADE OF METAL - JAW DIA -13MM**

- **Material** – hardened metal steel Fully Powder coated
- KRM LOTO Vinyl coated Hasp is used to Isolate the Electrical device for group locking, eight people can lock the device at a time and can be used on all type of power switches, it's tamper steel , insulation resin, flame proof resin.
- **Jaw diameter** - 13mm
- **Height** - 113mm
- **Weight** – 94 gm
- **Holes** – 8
- **Color** – Red Powder Coated

**KRM-K-LHPC-28**

ITEM CODE	OUTER LENGTH	JAW SIZE DIA	HOLE SIZE	NO OF HOLES	WEIGHT
KRM-K-LHPC28	113 mm	13 mm	10 mm	8	94gms



OEM Manufacturer & Global Supplier of
Lockout Tagout & Safety Products

to meet
OSHA'S Lockout Tagout Standard
29 CFR, 1910.147&1910.269



www.lotoappliances.com



Regd. Office:1H/31-A, N.I.T, Faridabad-121001 (Haryana) Postal Office:615, Sector-15-A, Faridabad-121007-Haryana-NCR-INDIA

www.krmcorporation.com | www.lockouttagouts.com | www.krmloto.com | www.locktagindia.com | www.lotoappliances.com

LOCKOUT/TAGOUT



**POWDER COATED LOCKOUT HASP MADE OF METAL
- JAW DIA -13MM**

CE
Certified



- Material – Hardened Metal Steel with fully Powder coated
- KRM LOTO Vinyl coated Hasp is used to isolate the Electrical device for group locking, six people can lock the device at a time and can be used on all type of power switches, it's tamper steel, insulation resin, flame proof resin.
- Jaw diameter 13/25 mm
- Height 113 mm
- Weight – 94/100 gm
- No. of Holes – 8
- Color – Red

KRM-K-LHPC-28/48

Item Code	Height	Jaw Size Dia	Hole Size	No.Of Holes	Weight
KRM-K-LHPC28	113mm	13mm	10mm	8	94gm
KRM-K-LHPC48	113mm	25mm	10mm	8	100gm



KRM LOTO POWDER COATED HASP MADE OF METAL - JAW DIA - 25MM

- **Material** – hardened metal steel Fully Powder coated
- KRM LOTO Vinyl coated Hasp is used to Isolate the Electrical device for group locking, eight people can lock the device at a time and can be used on all type of power switches, it's tamper steel , insulation resin, flame proof resin.
- **Jaw diameter** - 25mm
- **Height** - 13mm
- **Weight** – 100 gm for
- **Holes** – 8
- **Color** – Red Powder Coated



KRM-K-LHPC48

ITEM CODE	OUTER LENGTH	JAW SIZE DIA	HOLE SIZE	NO OF HOLES	WEIGHT
KRM-K-LHPC48	113 mm	25 mm	10 mm	8	100 gms



OEM Manufacturer & Global Supplier of
Lockout Tagout & Safety Products

to meet
OSHA'S Lockout Tagout Standard
29 CFR, 1910.147&1910.269



www.locktagindia.com



LOCKOUT/TAGOUT



**POWDER COATED LOCKOUT HASP MADE OF METAL
- JAW DIA -13MM**

CE
Certified



- Material – Hardened Metal Steel with fully Powder coated
- KRM LOTO Vinyl coated Hasp is used to isolate the Electrical device for group locking, six people can lock the device at a time and can be used on all type of power switches, it's tamper steel, insulation resin, flame proof resin.
- Jaw diameter 13/25 mm
- Height 113 mm
- Weight – 94/100 gm
- No. of Holes – 8
- Color – Red

KRM-K-LHPC-28/48

Item Code	Height	Jaw Size Dia	Hole Size	No.Of Holes	Weight
KRM-K-LHPC28	113mm	13mm	10mm	8	94gm
KRM-K-LHPC48	113mm	25mm	10mm	8	100gm



KRM LOTO LOCKOUT OCTA STOP HASP HAVING 6 HOLES

- Material**- Hardened Metal Steel with powder coated with identifiable label.
- KRM LOTO Octal Hasp is chemical /Oil resistance used to lock the device in OFF position OR permanent ON position ,accepts up to six locks for group isolation reliable temperature
- Range up to -30°F to 350°F (-35°C to 177°C)for hasp,-20°F(-35°C to 93°C)for label and 30°F to 350°F (-35°C to 177°C)for rivet.
- Dimension** - Height 140mm,Width 86mm and hole diameter is 9mm for placing the padlock.
- No. of hole** - 6
- Weight** - 100gm
- Color** - Red, Yellow, Green and Blue or any color make as per the required quantity.



KRM-K-LHOCG

ITEM CODE	HEIGHT	WIDTH	HOLE SIZE	NO OF HOLES	WEIGHT
KRM-K-LHOCG	140 mm	86 mm	9 mm	6	100 gms



OEM Manufacturer & Global Supplier of
Lockout Tagout & Safety Products

to meet
OSHA'S Lockout Tagout Standard
29 CFR, 1910.147&1910.269



www.lockoutappliances.com



LOCKOUT/TAGOUT



LOCKOUT OCTA STOP LOCKOUT HASP HAVING 6 HOLES

CE Certified



KRM-K-LHOCG

- **Material**- Hardened Metal Steel with powder coated with identifiable label.
- KRM LOTO Octal Hasp is chemical /Oil resistance used to lock the device in OFF position OR permanent ON position ,accepts up to six locks for group isolation reliable temperature
- Range up to -30°F to 350°F (-35°C to 177°C)for hasp,-20°F(-35°C to 93°C)for label and 30°F to 350°F (-35°C to 177°C)for rivet.
- **Dimension** - Height 140mm,Width 86mm and hole diameter is 9mm for placing the padlock.
- **No. of hole** - 6
- **Weight** - 100gm
- **Color** - Red, Yellow, Green and Blue or any color make as per the required quantity.

Item Code	Height	Width	Hole Size	No.of Holes	Weight
KRM-K-LHOCG	140mm	86mm	9mm	6	100gm



KRM LOTO LOCKOUT TOGGLE HASP

- **Material** – hardened Metal Steel with powder coated with label
- KRM LOTO Toggle Hasp is chemical/ Oil resistance used to lock the device in OFF position OR permanent ON position, accepts up to 3 locks for group Isolation Reliable temperature **205amp**
- **Dimension**-Height 127mm,width 35mm (in close position) width -46mm (in open position) and hole diameter is 9mm for placing the padlock.
- **Holes** - 3
- **Weight**-100gm
- **Color**-Red, Yellow, Green and Blue or any color make as per the required quantity.



KRM-K-LTOGH



ITEM CODE	HEIGHT	WIDTH OPEN POSITION	WIDTH CLOSE POSITION	HOLE SIZE	NO OF HOLES	WEIGHT
KRM-K-LHOGH	127 mm	46 mm	35 mm	9 mm	3	100 gms



OEM Manufacturer & Global Supplier of
Lockout Tagout & Safety Products

to meet
OSHA'S Lockout Tagout Standard
29 CFR, 1910.147&1910.269



www.lockouttagouts.com



LOCKOUT/TAGOUT



LOCKOUT TOGGLE HASP

KRM LOTO
EXPERT
CE
Certified



KRM-K-LTOGH

- Material – Hardened Metal Steel with powder coated with label
- KRM LOTO Toggle Hasp is chemical/ Oil resistance used to lock the device in OFF position OR permanent ON position, accepts up to 3 locks for group Isolation Reliable temperature 205amp
- Dimension - Height 127mm,Width 35mm (in close position) Width -46mm (in open position) and hole diameter is 9mm for placing the padlock.
- No. of Holes - 3
- Weight- 100gm
- Color- Red, Yellow, Green and Blue or any color make as per the required quantity.

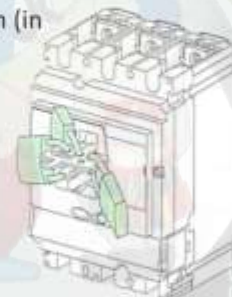

Item Code	Height	Width Open Position	Width Close Position	Hole Dia	No. of Holes	Weight
KRM-K-LHOGH	127mm	46mm	35mm	9mm	3	100gm



OEM Manufacturer & Global Supplier of
 Lockout Tagout & Safety Products

to meet
 OSHA'S Lockout Tagout Standard
 29 CFR, 1910.147&1910.269



www.lotoappliances.com



KRM LOTO HEAVY DUTY METAL MATERIAL - COLOR SILVER - INSIDE JAW DIA - 1" , SHACKLE -60-85MM

- **Material** –hardened metal steel with identifiable label.
- KRM LOTO Hardened metal Steel Hasp is ideal for all industries that is corrosion resistant and highly durable With One huge slot to be accommodated with maximum 3-4padlocks with shackle thickness 6 mm
- **Dimension** – Height – 85mm width 60mm inside Jaw Diameter 25mm
- **Weight** – 103gm
- **Color** – Silver metallic.



KRM-K-HDH-S

Item code	Height	width	Shackle height	Padlock Hole dia	Max padlock in slot	Weight
KRM-K-HDH-S	85mm	60mm	25mm	10mm	3-4padlocks	103gm



OEM Manufacturer & Global Supplier of
Lockout Tagout & Safety Products

to meet
OSHA'S Lockout Tagout Standard
29 CFR, 1910.147&1910.269



www.lotoappliances.com



www.krmcorporation.com | www.lockouttagouts.com | www.krmloto.com | www.locktagindia.com | www.lotoappliances.com

Regd. Office:1H/31-A, N.I.T, Faridabad-121001 (Haryana) Postal Office:615, Sector-15-A, Faridabad-121007-Haryana-NCR-INDIA

Email: info@krmloto.com, info@krmcorporation.com, krmloto@gmail.com

Regd. Office:1H/31-A, N.I.T, Faridabad-121001 (Haryana) Postal Office:615, Sector-15-A, Faridabad-121007-Haryana-NCR-INDIA

LOCKOUT/TAGOUT



KRM LOTO
EXPERT

CE
Certified

HEAVY DUTY METALIC LOCKOUT HASP



KRM-K-HDH-S

- **Material** – Hardened Metal Steel with identifiable label.
- KRM LOTO Hardened Metal Steel Hasp is ideal for all industries that is corrosion resistant and highly durable With One huge slot to be accommodated with maximum three to four padlocks with shackle thickness 6 mm
- **Dimension** – height 85mm, width 60mm inside Shackle Height 25mm
- **Weight** – 103gm
- **Color** – Silver metallic

Item Code	Height	Width	Shackle Height	Padlock HoleDia	Max Padlocks in slot	Weight
KRM-K-HDH-S	85mm	60mm	25mm	10mm	3-4 padlocks	103gm

KRM CORPORATION

ISO 9001:2015, ISO 14001:2015, ISO 45001:2018
to meet OSHA's Lockout Tagout Standard 29 CFR, 1910.147&1910.269

KM Safetech Private Limited

QUALITY MANAGEMENT SYSTEM ISO 9001:2015

M: 00 91 9810 291 381, 8800 544 881, T: 00 91 129 - 4021 381

info@krmcorporation.com, info@krmloto.com, krmloto@gmail.com, wadhwarajinder@gmail.com

Postal Add: 615, Sector-15A, Faridabad-121007 Haryana - NCR (INDIA)
Regd. Office: 1H/31A, N.I.T, Faridabad-121001

www.krmloto.com www.krmcorporation.com, www.safetyloto.com
www.lotoappliances.com, www.lockouttagouts.com

032



OEM Manufacturer & Global Supplier of
 Lockout Tagout & Safety Products

to meet
 OSHA'S Lockout Tagout Standard
 29 CFR, 1910.147&1910.269



www.lotoappliances.com



KRM LOTO HEAVY DUTY METAL HASP - COLOR SILVER - INSIDE JAW DIA - 1" , SHACKLE - 60-165MM

Material – hardened metal steel with identifiable label.

KRM LOTO metallic Hasp is ideal for all industries that is corrosion resistant and highly durable With One huge slot to be accommodated with maximum four to five padlocks with shackle thickness 6mm

Dimension –height 165mm, width 60mm inside Shackle height 70mm

Weight – 185gm

Color – Silver metallic



KRM-K-HDH-P

Item code	Height	width	Shackle height	Padlock Hole dia	Max Padlock in slot	Weight
KRM-K-HDH-P	165mm	60mm	70mm	10mm	4-5padlocks	185gms



OEM Manufacturer & Global Supplier of
Lockout Tagout & Safety Products

to meet
OSHA'S Lockout Tagout Standard
29 CFR, 1910.147&1910.269

www.lockouttagouts.com



Regd. Office: 1H/31-A, N.I.T, Faridabad-121001 (Haryana) Postal Office: 615, Sector-15-A, Faridabad-121007-Haryana-NCR-INDIA

www.krmcorporation.com | www.lockouttagouts.com | www.krmloto.com | www.locktagindia.com | www.lotoappliances.com

LOCKOUT/TAGOUT



HEAVY DUTY METALIC LOCKOUT HASP

KRM LOTO
EXPERT

CE
Certified



KRM-K-HDH-P

- **Material** – Hardened Metal Steel with identifiable label.
- KRM LOTO Hardened Metal Steel Hasp is ideal for all industries that is corrosion resistant and highly durable With One huge slot to be accommodated with maximum four to five padlocks with shackle thickness 6 mm
- **Dimension** – height 165mm, width 60mm inside Shackle Height 70mm
- **Weight** – 185gm
- **Color** – Silver metallic

Item Code	Height	Width	Shackle Height	Padlock HoleDia	Max Padlocks in slot	Weight
KRM-K-HDH-P	165mm	60mm	70mm	10mm	4-5 padlocks	185gm



OEM Manufacturer & Global Supplier of
Lockout Tagout & Safety Products

to meet
OSHA'S Lockout Tagout Standard
29 CFR, 1910.147&1910.269



www.lockouttagouts.com



KRM LOTO METAL HASP – WITHOUT ANY CHAIN

- **Material** –hardened metal steel
- KRM LOTO metal Hasp is accessible with 6 lockable holes of 8.3 mm hole dia.shackle thickness 5mm
- **Dimension** – shackle Width 25 mm,
- Width – 50mm
- Height – 115 gm
- **Weight** – 100 gm
- **Color** – silver metallic finish



KRM-K-SST

Item code	HEIGHT	Shackle Height	Width	No of holes	Shackle width	Shackle Thickness	Weight
KRM-K-SST	115mm	35mm	50mm	6	25mm	5mm	100gm



OEM Manufacturer & Global Supplier of
Lockout Tagout & Safety Products

to meet
OSHA'S Lockout Tagout Standard
29 CFR, 1910.147 & 1910.269



www.lockouttagouts.com



Regd. Office: 1H/31-A, N.I.T, Faridabad-121001 (Haryana) | Postal Office: 615, Sector-15-A, Faridabad-121007-Haryana-NCR-INDIA

www.krmcorporation.com | www.lockouttagouts.com | www.krmloto.com | www.locktagindia.com | www.lotoappliances.com

LOCKOUT/TAGOUT



STAINLESS STEEL LOCKOUT HASP

KRM LOTO
EXPERT

CE
Certified



KRM-K-SST



- **Material** – Hardened Metal Steel
- **KRM LOTO Hardened Metal Steel Hasp** is accessible with 6 lockable holes of 8.3mm hole dia shackle thickness 5mm
- **Dimension** – Shackle Width 25 mm Shackle Height 35 mm
- **Body Width** – 50mm
- **Total Height** – 115mm
- **Weight** – 100 gm
- **Color** – Silver Metallic Finish

Item Code	Height	Shackle Height	Width	No. of Holes	Shackle Width	Shackle Thickness	Weight
KRM-K-SST	115mm	35mm	50mm	6	25mm	5mm	100gm

GSTIN No.: 06AACPW8746Q126,
PAN No.: AACPW8746Q
TIN No.: 06821328889,
TAN no.: RTKKO3359G
IEC: 0509006116

M: 00 91 9810 291 381, 8900 544 881



OEM Manufacturer & Global Supplier of
Lockout Tagout & Safety Products

to meet
OSHA'S Lockout Tagout Standard
29 CFR, 1910.147&1910.269



www.lotoappliances.com



GSTIN No.: 06AAECK2831L1Z1
PAN No.: AAECK2831L
TIN No.: 06824000112
CIN No.: U31903HR2011PTC042508
IEC: AAECK2831L

Telefax: 00 91 129 4021 381, 413 1381 (D)

Regd. Office: 1H/31-A, N.I.T, Faridabad-121001 (Haryana) Postal Office: 615, Sector-15-A, Faridabad-121007-Haryana-NCR-INDIA

www.krmcorporation.com | www.lockouttagouts.com | www.krmloto.com | www.locktagindia.com | www.lotoappliances.com

KRM LOTO METAL HASP – WITHOUT ANY CHAIN

LOCKOUT/TAGOUT

- **Material** – Hardened Metal Steel with Power Coated
- KRM LOTO Hardened Metal Steel Hasp is accessible with 6 lockable holes of 8.3 mm hole dia shackle thickness 5mm accompanied with warning, caution or danger printed label.
- **Dimension** – Shackle Width 25 mm Shackle Height 35 mm
- **Body Width** – 50mm
- **Total Height** – 115mm
- **Weight** – 100 gm
- **Color** – Yellow/Black

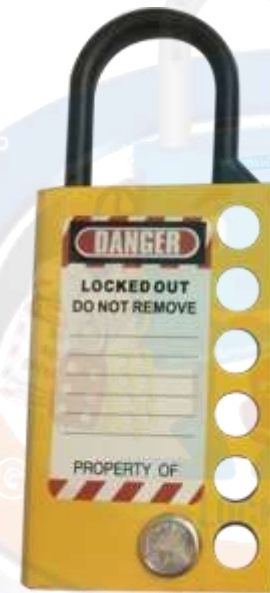

KRM-K-SST-Y

Item code	HEIGHT	Shackle Height	Width	No of holes	Shackle width	Shackle Thickness	Weight
KRM-K-SST-Y	115mm	35mm	50mm	6	25mm	5mm	110gm



OEM Manufacturer & Global Supplier of
Lockout Tagout & Safety Products

to meet
OSHA'S Lockout Tagout Standard
29 CFR, 1910.147&1910.269



www.locktagindia.com



LOCKOUT/TAGOUT



KRM LOTO
EXPERT

CE
Certified

METAL LOCKOUT HASP



- **Material** – Hardened Metal Steel with Power Coated
- KRM LOTO Hardened Metal Steel Hasp is accessible with 6 lockable holes of 8.3 mm hole dia shackle thickness 5mm accompanied with warning, caution or danger printed label.
- **Dimension** – Shackle Width 25 mm Shackle Height 35 mm
- **Body Width** – 50mm
- **Total Height** – 115mm
- **Weight** – 100 gm
- **Color** – Yellow/Black

KRM-K-SST-Y

Item Code	Height	Shackle Height	Width	No.of Holes	Shackle Width	Shackle Thickness	Weight
KRM-K-SST-Y	115mm	35mm	50mm	6	25mm	5mm	110gm

GSTIN No.: 06AAMPW8746Q1Z6,
PAN No.: AAVPW8746Q
TIN No.: 06821328889,
TAN no.: RTKKO3359G
IEC: 0509006116

M: 00 91 9810 291 381, 8900 544 881



OEM Manufacturer & Global Supplier of
Lockout Tagout & Safety Products

to meet
OSHA'S Lockout Tagout Standard
29 CFR, 1910.147&1910.269



www.lotoappliances.com



GSTIN No.: 06AAECK2831L1ZI
PAN No.: AAECK2831L
TIN No.: 06824000112
CIN No.: U31903HR2011PTC042508
IEC: AAECK2831L

Telefax: 00 91 129 4021 381, 413 1381 (D)

Regd. Office: 1H/31-A, N.I.T, Faridabad-121001 (Haryana) Postal Office: 615, Sector-15-A, Faridabad-121007-Haryana-NCR-INDIA

www.krmcorporation.com

www.lockouttagouts.com

www.krmloto.com

www.locktagindia.com

www.lotoappliances.com

KRM LOTO PLASTIC BODY LOCKOUT HASP HAVING 2 HOLES TO ACCOMMODATE THE PADLOCKS AND CAN ADD MORE LOCK WITH ADDITION HASP

- **Material** – metal shackle, plastic body
- KRM LOTO Master Safety Hasp Plastic / steel Hasp is accessible with one small holes and 4mm diameter printed label. 4mm steel hasp fits smaller lockout points
- **Dimension** – width - 57mm height - 76mm - depth- 25mm) inside jaw diameter, holds up to 2 padlocks
- **Weight** – 125 gm
- **Color** – Red body with Metal shackle or any color make as per the required quantity



KRM-K-SPH2

Item code	WIDTH	HEIGHT	DEPTH	Shackle thickness	No of holes	Weight
KRM-K-SPH2	57mm	76mm	25mm	4mm	02	125gm



OEM Manufacturer & Global Supplier of
Lockout Tagout & Safety Products

to meet
OSHA'S Lockout Tagout Standard
29 CFR, 1910.147&1910.269



www.lotoappliances.com



LOCKOUT/TAGOUT



PLASTIC BODY LOCKOUT HASP HAVING 2 HOLES TO ACCOMMODATE THE PADLOCKS AND CAN ADD MORE LOCK WITH ADDITION HASP

CE Certified



KRM-K-SPH2

- **Material** – Metal shackle Plastic body
- KRM LOTO Master Safety Hasp Plastic / steel Hasp is accessible with one small holes and 4mm diameter printed label. 4mm steel hasp fits smaller lockout points
- **Dimension** – (height - 76mm - width - 57mm - depth- 25mm) inside jaw diameter, holds up to 2 padlocks
- **Weight** – 125 gm
- **Color** – Red body with metal shackle or any color make as per the required quantity

ITEM CODE	HEIGHT	WIDTH	DEPTH	SHACKLE THICKNESS	NO. OF HOLES	Weight
KRM-K-SPH2	76mm	57mm	25mm	4mm	02	125gm



**OEM Manufacturer & Global Supplier of
Lockout Tagout & Safety Products**

to meet
OSHA'S Lockout Tagout Standard
29 CFR, 1910.147&1910.269



www.locktagindia.com



KRM LOTO METAL DUAL JAW LOCKOUT HASP WITH CHROME FINISH - JAW SIZE 25 MM AND 38 MM WITH 8 HOLES

- Material – Hardened Metal Steel/ Hardened Metal Steel with powder coated
- KRM LOTO Dual Jaw Hasp ensures each worker's safety as the energy cannot be restored until the work is finished utilized to lock electrical devices like plug and cord which is also suitable for keeping equipment inoperative while repairs or adjustments are undertaken.
- **Dimension** – Overall height 151 mm, Hasp having two different jaw diameter of 25mm and 38 mm at both ends with 8 holes for locking having 11 mm of diameter.
- **Weight** – 180 gm
- **Color** – Red/Silver or any color make as per the required quantity



KRM-K-MDJH8



KRM-K-MDJH-R8

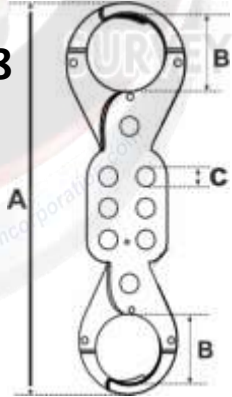

Item code	Outer Height	jaw dia	Hole dia	No of holes	Weight
KRM-K-MDJH8	151mm	25/38mm	11mm	8	180gm
KRM-K-MDJH-R8	151mm	25/38mm	11mm	8	190gm



LOCKOUT/TAGOUT



METAL DUAL JAW LOCKOUT HASP

KRM LOTO
EXPERT

CE
Certified



- **Material** – Hardened Metal Steel/ Hardened Metal Steel with powder coated
- **KRM LOTO Dual Jaw Hasp** ensures each worker's safety as the energy cannot be restored until the work is finished utilized to lock electrical devices like plug and cord which is also suitable for keeping equipment inoperative while repairs or adjustments are undertaken.
- **Dimension** – Overall height 151 mm, Hasp having two different jaw diameter of 25 mm and 38 mm at both ends with 8 holes for locking having 11 mm of diameter.
- **Weight** – 180 gm
- **Color** – Red/Silver or any color make as per the required quantity



KRM-K-MDJH-R8 KRM-K-MDJH8

Item code	Outer height(A)	Jaw Dia(B)	Hole Dia(C)	No of holes	Weight
KRM-K-MDJH8	151mm	25/38mm	11mm	8	180gm
KRM-K-MDJH-R8	151mm	25/38mm	11mm	8	190gm

GSTIN No.: 06AAVPW8746Q1Z6,
PAN No.: AAVPW8746Q
TIN No.: 06821328889,
TAN no.: RTKKO3359G
IEC: 0509006116

M: 00 91 9810 291 381, 8900 544 881



OEM Manufacturer & Global Supplier of
Lockout Tagout & Safety Products

to meet
OSHA'S Lockout Tagout Standard
29 CFR, 1910.147&1910.269



www.lotoappliances.com



GSTIN No.: 06AAECK2831L1Z1
PAN No.: AAECK2831L
TIN No.: 06824000112
CIN No.: U31903HR2011PTC042508
IEC: AAECK2831L

Telefax: 00 91 129 4021 381, 413 1381 (D)

Regd. Office:1H/31-A, N.I.T, Faridabad-121001 (Haryana) Postal Office:615, Sector-15-A, Faridabad-121007-Haryana-NCR-INDIA

www.krmcorporation.com | www.lockouttagouts.com | www.krmloto.com | www.locktagindia.com | www.lotoappliances.com

KRM LOTO UNIVERSAL DUAL JAW LOCKOUT HASP - METAL- 6 HOLES

- **Material** – hardened metal steel
- KRM Loto Universal Dual Jaw Hasp ensures each worker's safety as the energy cannot be restored until the work is finished utilized to lock electrical devices like plug and cord which is also suitable for keeping equipment inoperative while repairs or adjustments are undertaken. Totally 6 holes are given for multiple lockout.
- **Top jaw dia** - 38mm,
- **Bottom jaw** - 25mm,
- **Hole Dia** 09mm,
- **Dimension** – Overall height 152 mm, Hasp having two different jaw diameter of 25 mm and 38 mm at both ends with 6 small holes for locking having 9 mm of diameter.
- **Color** – silver metallic finish



KRM-K-UDJLH

Item code	Height	Jaw Size Dia	Hole Dia	Holes	Weight
KRM-K-UDJLH	152mm	38/25mm	09mm	6	110gm



OEM Manufacturer & Global Supplier of
Lockout Tagout & Safety Products

to meet
OSHA'S Lockout Tagout Standard
29 CFR, 1910.147&1910.269



www.locktagindia.com



LOCKOUT/TAGOUT



UNIVERSAL DUAL JAW LOCKOUT HASP

KRM LOTO
EXPERT
CE Certified



KRM-K-UDJLH

- **Material** – Hardened Metal Steel/ Hardened Metal Steel with powder coated
- KRM Loto Universal Dual Jaw Hasp ensures each worker's safety as the energy cannot be restored until the work is finished utilized to lock electrical devices like plug and cord which is also suitable for keeping equipment inoperative while repairs or adjustments are undertaken. Totally 6 holes are given for multiple lockout.
- **Top jaw dia** - 38mm,
- **Bottom jaw dia** - 25mm
- **Hole Dia** 9mm
- **Dimension** – Overall height 152 mm, Hasp having two different jaw diameter of 25 mm and 38 mm at both ends with 6 small holes for locking having 9 mm of diameter.
- **Color** – Silver Metallic Finish/Red or any color make as per the required quantity

Item Code	Outer height	Jaw Size Dia	Hole Dia	No.Of Holes	WEIGHT
KRM-K-UDJLH	152mm	25/38mm	9mm	6	110gms





OEM Manufacturer & Global Supplier of
 Lockout Tagout & Safety Products

to meet
 OSHA'S Lockout Tagout Standard
 29 CFR, 1910.147&1910.269



www.locktagindia.com



KRM LOTO VINYL MOLDED COATED HASP – STEEL – SMALL - JAW DIA - 25 MM

- **Material** – hardened metal steel with Vinyl molded coated on grip
- KRM LOTO Vinyl molded coated Hasp is used to lock the device in OFF position OR permanent ON position accepts up to six locks for group Isolation with de energized insulated grip. Available in two different sizes small and premier.
- **Dimension** – Jaw diameter 25 mm for small hasp
- **Height** – 113 mm for small hasp
- **Weight** – 80gm for small hasp
- **Color** – Red, Yellow, Green and Blue or any color make as per the required quantity

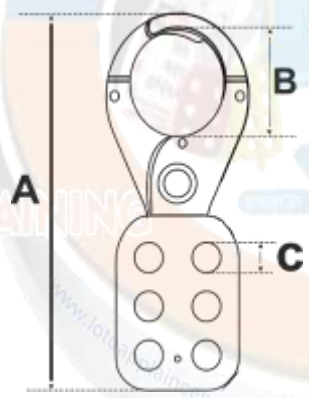

KRM-K-VCH-SS-R-S25

Item code	HEIGHT(A)	Jaw Size Dia(B)	Padlock Hole Dia(C)	No of holes	Weight
KRM-K-VCH-SS-R-S-25	113mm	25mm	9mm	6	80gm



OEM Manufacturer & Global Supplier of
Lockout Tagout & Safety Products

to meet
OSHA'S Lockout Tagout Standard
29 CFR, 1910.147&1910.269



www.locktagindia.com



LOCKOUT/TAGOUT



CE
Certified

VINYL MOLDED COATED LOCKOUT HASP – STEEL

- **Material** – Hardened Metal Steel with Vinyl molded coated on grip
- KRM LOTO Vinyl molded coated Hasp is used to lock the device in OFF position OR permanent ON position accepts up to six locks for group Isolation with de energized insulated grip. Available in two different sizes small and premier.
- **Dimension** – Jaw diameter 25 mm for small hasp with height 113 mm Jaw diameter 38/39 mm for premier hasp with height 128 mm
- **Weight** – 80 gm for small hasp & 90 gm for premier hasp
- **Color** – Red, Yellow, Green and Blue or any color make as per the required quantity

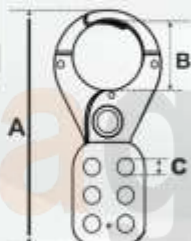

KRM-K-VCH-SS-R-S25

KRM-K-VCH-SS-R-P-38/39

ITEM CODE	Height	Jaw Size Dia (B)	Padlock Hole Dia (C)	No.Of Holes	WEIGHT
KRM-K-VCH-SS-R-S-25	113mm	25mm	9 mm	6	80gms
KRM-K-VCH-SS-R-P-38/39	128mm	38/39mm	9 mm	6	90gms

GSTIN No.: 06AACPW8746Q1Z6,
PAN No.: AACPW8746Q
TIN No.: 06821328889,
TAN no.: RTKKO3359G
IEC: 0509006116

M: 00 91 9810 291 381, 8900 544 881



OEM Manufacturer & Global Supplier of
Lockout Tagout & Safety Products

to meet
OSHA'S Lockout Tagout Standard
29 CFR, 1910.147&1910.269



www.lotoappliances.com



GSTIN No.: 06AAECK2831L1Z1
PAN No.: AAECK2831L
TIN No.: 06824000112
CIN No.: U31903HR2011PTC042508
IEC: AAECK2831L

Telefax: 00 91 129 4021 381, 413 1381 (D)

Regd. Office: 1H/31-A, N.I.T, Faridabad-121001 (Haryana) Postal Office: 615, Sector-15-A, Faridabad-121007-Haryana-NCR-INDIA

www.krmcorporation.com | www.lockouttagouts.com | www.krmloto.com | www.locktagindia.com | www.lotoappliances.com

KRM LOTO VINYL MOLDED COATED HASP – STEEL – PREMIER – JAW DIA – 38/39 MM

- **Material** – hardened metal steel with Vinyl molded coated on grip
- KRM LOTO Vinyl molded coated Hasp is used to lock the device in OFF position OR permanent ON position accepts up to six locks for group Isolation with de energized insulated grip. Available in two different sizes small and premier.
- **Dimension** – Jaw diameter 38/39 mm for premier hasp
- **Height** – 128 mm for premier hasp
- **Weight** – 90gm
- **Color** – Red, Yellow, Green and Blue or any color make as per the required quantity



KRM-K-VCH-SSR-P-38/39

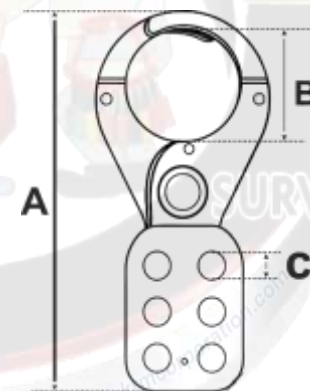

Item code	HEIGHT (A)	Jaw Size Dia(B)	Padlock Hole Dia(C)	No of holes	Weight
KRM-K-VCH-SS-R-P-38/39	128mm	38mm	9mm	6	90gm



OEM Manufacturer & Global Supplier of
Lockout Tagout & Safety Products

to meet
OSHA'S Lockout Tagout Standard
29 CFR, 1910.147&1910.269



www.lockoutappliances.com



LOCKOUT/TAGOUT



CE
Certified

VINYL MOLDED COATED LOCKOUT HASP – STEEL

- **Material** – Hardened Metal Steel with Vinyl molded coated on grip
- KRM LOTO Vinyl molded coated Hasp is used to lock the device in OFF position OR permanent ON position accepts up to six locks for group Isolation with de energized insulated grip. Available in two different sizes small and premier.
- **Dimension** – Jaw diameter 25 mm for small hasp with height 113 mm Jaw diameter 38/39 mm for premier hasp with height 128 mm
- **Weight** – 80 gm for small hasp & 90 gm for premier hasp
- **Color** – Red, Yellow, Green and Blue or any color make as per the required quantity

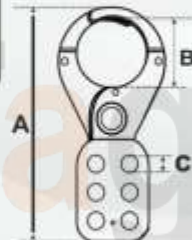

KRM-K-VCH-SS-R-S25

KRM-K-VCH-SS-R-P-38/39

ITEM CODE	Height	Jaw Size Dia (B)	Padlock Hole Dia (C)	No.Of Holes	WEIGHT
KRM-K-VCH-SS-R-S-25	113mm	25mm	9 mm	6	80gms
KRM-K-VCH-SS-R-P-38/39	128mm	38/39mm	9 mm	6	90gms



OEM Manufacturer & Global Supplier of
 Lockout Tagout & Safety Products

to meet
 OSHA'S Lockout Tagout Standard
 29 CFR, 1910.147&1910.269



www.locktagindia.com



KRM LOTO ALUMINIUM BASE MOLDED COATED GRIP HASP -SMALL - JAW DIA -25 MM LIGHT WEIGHT - 4COLOR AVAILABLE - R/G/B/Y

- **Material** - Aluminium with Vinyl Coated at Grip
- **Hasp jaw dia** - 25mm
- **HEIGHT** - 113mm
- **Weight** - 45gms
- **Color** - Red, Yellow , Green , Blue or any other color as required.



KRM-K-AMCH-S25

Item code	HEIGHT	Jaw Size Dia	Padlock Hole Dia	No of holes	Weight
KRM-K-AMCH-S-25	113mm	25mm	09mm	06	45gm



OEM Manufacturer & Global Supplier of
Lockout Tagout & Safety Products

to meet
OSHA'S Lockout Tagout Standard
29 CFR, 1910.147&1910.269



www.lotoappliances.com



Regd. Office:1H/31-A, N.I.T, Faridabad-121001 (Haryana) Postal Office:615, Sector-15-A, Faridabad-121007-Haryana-NCR-INDIA

www.krmcorporation.com | www.lockouttagouts.com | www.krmloto.com | www.locktagindia.com | www.lotoappliances.com

LOCKOUT/TAGOUT



ALUMINIUM BASE MOLDED COATED GRIP LOCKOUT HASP

- **Material** - Aluminium with Vinyl Coated at Grip
- **Dimension** – Jaw diameter 25 mm for small hasp with height 113 mm Jaw diameter 38/39 mm for premier hasp with height 128 mm
- **Weight** – 45 gm for small hasp & 55 gm for premier hasp
- **Color** – Red, Yellow, Green and Blue or any color make as per the required quantity



KRM-K-AMCH-S-25 KRM-K-AMCH-P-38/39

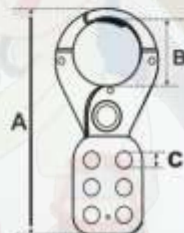

ITEM CODE	OUTER HEIGHT	JAW SIZE DIA	HOLE SIZE	NO. OF HOLES	Weight
KRM-K-AMCH-S-25	113mm	25mm	9mm	06	45gm
KRM-K-AMCH-P-38/39	128mm	38/39mm	9mm	06	55gm



KRM LOTO ALUMINUM BASE MOLDED COATED GRIP HASP - PREMIER - JAW DIA 38/39 MM

- **Material** - Aluminium with Vinyl Coated at Grip
- **Hasp jaw dia** – 38/39mm
- **HEIGHT** - 128mm
- **Weight** - 55gms
- **Color** - Red, Yellow, Green, Blue or any other color as required



KRM-K-AMCH-P-38/39

Item code	Height	Jaw Size Dia	Padlock Hole Dia	No of holes	Weight
KRM-K-AMCH-P-38/39	128	38/39mm	09mm	06	55gm



OEM Manufacturer & Global Supplier of
Lockout Tagout & Safety Products

to meet
OSHA'S Lockout Tagout Standard
29 CFR, 1910.147&1910.269



www.lockoutappliances.com



Regd. Office: 1H/31-A, N.I.T, Faridabad-121001 (Haryana) Postal Office: 615, Sector-15-A, Faridabad-121007-Haryana-NCR-INDIA

www.krmcorporation.com | www.lockouttagouts.com | www.krmloto.com | www.locktagindia.com | www.lotoappliances.com

LOCKOUT/TAGOUT



ALUMINIUM BASE MOLDED COATED GRIP LOCKOUT HASP

- **Material** - Aluminium with Vinyl Coated at Grip
- **Dimension** – Jaw diameter 25 mm for small hasp with height 113 mm Jaw diameter 38/39 mm for premier hasp with height 128 mm
- **Weight** – 45 gm for small hasp & 55 gm for premier hasp
- **Color** – Red, Yellow, Green and Blue or any color make as per the required quantity



KRM-K-AMCH-S-25 KRM-K-AMCH-P-38/39

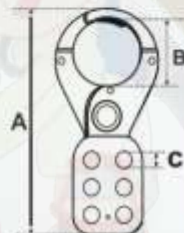

ITEM CODE	OUTER HEIGHT	JAW SIZE DIA	HOLE SIZE	NO. OF HOLES	Weight
KRM-K-AMCH-S-25	113mm	25mm	9mm	06	45gm
KRM-K-AMCH-P-38/39	128mm	38/39mm	9mm	06	55gm

GSTIN No.: 06AAPW8746Q1Z6,
PAN No.: AAVPW8746Q
TIN No.: 06821328889,
TAN no.: RTKKO3359G
IEC: 0509006116

M: 00 91 9810 291 381, 8900 544 881



OEM Manufacturer & Global Supplier of
Lockout Tagout & Safety Products

to meet
OSHA'S Lockout Tagout Standard
29 CFR, 1910.147&1910.269



www.lotoappliances.com



GSTIN No.: 06AAECK2831L1Z1
PAN No.: AAECK2831L
TIN No.: 06824000112
CIN No.: U31903HR2011PTC042508
IEC: AAECK2831L

Telefax: 00 91 129 4021 381, 413 1381 (D)

Regd. Office: 1H/31-A, N.I.T, Faridabad-121001 (Haryana) Postal Office: 615, Sector-15-A, Faridabad-121007-Haryana-NCR-INDIA

www.krmcorporation.com | www.lockouttagouts.com | www.krmloto.com | www.locktagindia.com | www.lotoappliances.com

KRM LOTO ALUMINIUM DUAL JAW HASP - JAW DIA 25 AND 38 MM WITH 10 HOLES

- **Material** – Aluminium
- KRM LOTO Aluminum Dual Jaw Hasp ensures each worker's safety as the energy cannot be restored until the work is finished utilized to lock electrical devices like plug and cord which is also suitable for keeping equipment inoperative while repairs or adjustments are undertaken.
- Height 152 mm,
- hole dia for padlock 9mm.
- **Top jaw dia** - 38mm,
- **Bottom jaw** - 25mm,
- **Weight** – 150gm
- Holes – 10 holes
- **Color** – silver metallic finish



KRM-K-ADJH10

Item code	Height	Jaw Size Dia	Padlock Hole Dia	No of holes	Weight
KRM-K-ADJH-10	152mm	25/38mm	9mm	10	150gm



OEM Manufacturer & Global Supplier of
Lockout Tagout & Safety Products

to meet
OSHA'S Lockout Tagout Standard
29 CFR, 1910.147&1910.269



www.lotoappliances.com



LOCKOUT/TAGOUT



ALUMINIUM DUAL JAW LOCKOUT HASP

CE Certified



KRM-K-ADJH-8



KRM-K-ADJH-10

- Material – Aluminium
- KRM LOTO Aluminium Dual Jaw Hasp ensures each worker's safety as the energy cannot be restored until the work is finished utilized to lock electrical devices like plug and cord which is also suitable for keeping equipment inoperative while repairs or adjustments are undertaken.
- Height – 151/152mm
- Hole Dia for padlock 9mm
- Weight – 145gm for 8 holes and 150gm for 10 holes
- No. of Holes – 8/10 holes
- Color – Silver Metallic finish

ITEM CODE	Outer Height	Jaw Size Dia	Hole Size	NO. OF HOLES	Weight
KRM-K-ADJH-8	151mm	25mm	9mm	08	145gm
KRM-K-ADJH-10	152mm	25/38mm	9mm	10	150gm

GSTIN No.: 06AACPW8746Q1Z6,
PAN No.: AACPW8746Q
TIN No.: 06821328889,
TAN no.: RTKKO3359G
IEC: 0509006116

M: 00 91 9810 291 381, 8900 544 881

Regd. Office: 1H/31-A, N.I.T, Faridabad-121001 (Haryana) Postal Office: 615, Sector-15-A, Faridabad-121007-Haryana-NCR-INDIA

www.krmcorporation.com | www.lockouttagouts.com | www.krmloto.com | www.locktagindia.com | www.lotoappliances.com



OEM Manufacturer & Global Supplier of
Lockout Tagout & Safety Products

to meet
OSHA'S Lockout Tagout Standard
29 CFR, 1910.147&1910.269



www.lotoappliances.com

Email: info@krmloto.com, info@krmcorporation.com, krmloto@gmail.com



GSTIN No.: 06AAECK2831L1Z1
PAN No.: AAECK2831L
TIN No.: 06824000112
CIN No.: U31903HR2011PTC042508
IEC: AAECK2831L

Telefax: 00 91 129 4021 381, 413 1381 (D)

KRM LOTO ALUMINIUM DUAL JAW HASP - JAW DIA 25 AND 38 MM WITH 8 HOLES

- **Material** – Aluminium
- KRM LOTO Aluminum Dual Jaw Hasp ensures each worker's safety as the energy cannot be restored until the work is finished utilized to lock electrical devices like plug and cord which is also suitable for keeping equipment inoperative while repairs or adjustments are undertaken.
- Height 152 mm,
- hole dia for padlock 9mm.
- **Weight** – 145gm
- **Holes** – 8 holes
- **Color** – silver metallic finish



KRM-K-ADJH8

Item code	Height	Jaw Size Dia	Padlock Hole Dia	No of holes	Weight
KRM-K-ADJH-8	152mm	25mm	9mm	08	145gm

GSTIN No.: 06AAVPW8746Q1Z6,
PAN No.: AAVPW8746Q
TIN No.: 0682132889,
TAN no.: RTKKO3359G
IEC: 0509006116

M: 00 91 9810 291 381, 8800 544 881



OEM Manufacturer & Global Supplier of
Lockout Tagout & Safety Products

to meet
OSHA'S Lockout Tagout Standard
29 CFR, 1910.147&1910.269



www.lockouttagouts.com



GSTIN No.: 06AAECK2831L1Z1
PAN No.: AAECK2831L
TIN No.: 06824000112
CIN No.: U31903HR2011PTC042508
IEC: AAECK2831L

Telefax: 00 91 129 4021 381, 413 1381 (D)

Regd. Office: 1H/31-A, N.I.T, Faridabad-121001 (Haryana) Postal Office: 615, Sector-15-A, Faridabad-121007-Haryana-NCR-INDIA

www.krmcorporation.com | www.lockouttagouts.com | www.krmloto.com | www.locktagindia.com | www.lotoappliances.com

LOCKOUT/TAGOUT



LOCKOUT/TAGOUT
KRM-LOTO
SAFETY PRODUCTS
safe loto

ALUMINIUM DUAL JAW LOCKOUT HASP

KRM LOTO
EXPERT

CE
Certified



KRM-K-ADJH-8

KRM-K-ADJH-10

- Material – Aluminium
- KRM LOTO Aluminium Dual Jaw Hasp ensures each worker's safety as the energy cannot be restored until the work is finished utilized to lock electrical devices like plug and cord which is also suitable for keeping equipment inoperative while repairs or adjustments are undertaken.
- Height – 151/152mm
- Hole Dia for padlock 9mm
- Weight – 145gm for 8 holes and 150gm for 10 holes
- No. of Holes – 8/10 holes
- Color – Silver Metallic finish

ITEM CODE	Outer Height	Jaw Size Dia	Hole Size	NO. OF HOLES	Weight
KRM-K-ADJH-8	151mm	25mm	9mm	08	145gm
KRM-K-ADJH-10	152mm	25/38mm	9mm	10	150gm

KRM CORPORATION

ISO 9001:2015, ISO EMS 14001:2015, ISO OHSMS 45001:2018
to meet OSHA'S Lockout Tagout Standard 29 CFR, 1910.147&1910.269

Postal Add: 615, Sector-15A, Faridabad-121007 Haryana - NCR (INDIA)
Regd. Office: 1H/31A, N.I.T, Faridabad-121001

KMSafetech Private Limited

QUALITY MANAGEMENT SYSTEM ISO 9001:2015

M: 00 91 9810 291 381, 8800 544 881, T: 00 91 129 - 4021 381

info@krmcorporation.com, info@krmloto.com, krmloto@gmail.com, wadhwrajinder@gmail.com

www.krmloto.com www.krmcorporation.com, www.safetyloto.com
www.lotoappliances.com, www.lockouttagouts.com



OEM Manufacturer & Global Supplier of
 Lockout Tagout & Safety Products

to meet
 OSHA'S Lockout Tagout Standard
 29 CFR, 1910.147&1910.269

Email: info@krmloto.com, info@krmcorporation.com, krmloto@gmail.com

Regd. Office:1H/31-A, N.I.T, Faridabad-121001 (Haryana) Postal Office:615, Sector-15-A, Faridabad-121007-Haryana-NCR-INDIA

www.krmcorporation.com | www.lockouttagouts.com | www.krmloto.com | www.locktagindia.com | www.lotoappliances.com



KRM LOTO ALUMINUM GROUP LOCKOUT HASP - JAW DIA 25 MM

- **Material** –Aluminium with Vinyl coated at grip
- KRM LOTO Vinyl coated Hasp is used to lock the device in OFF position OR permanent ON position accepts up to 6 padlocks for group Isolation with de energized insulated grip and non sparking Aluminum. Available in two different sizes small and premier.
- **Dimension** – Jaw diameter 25 mm for small hasp with height 113mm
- **Weight** – 70gm
- No. of Holes – 6
- **Color** – Red, Yellow, Green and Blue Or any color make as per the required quantity

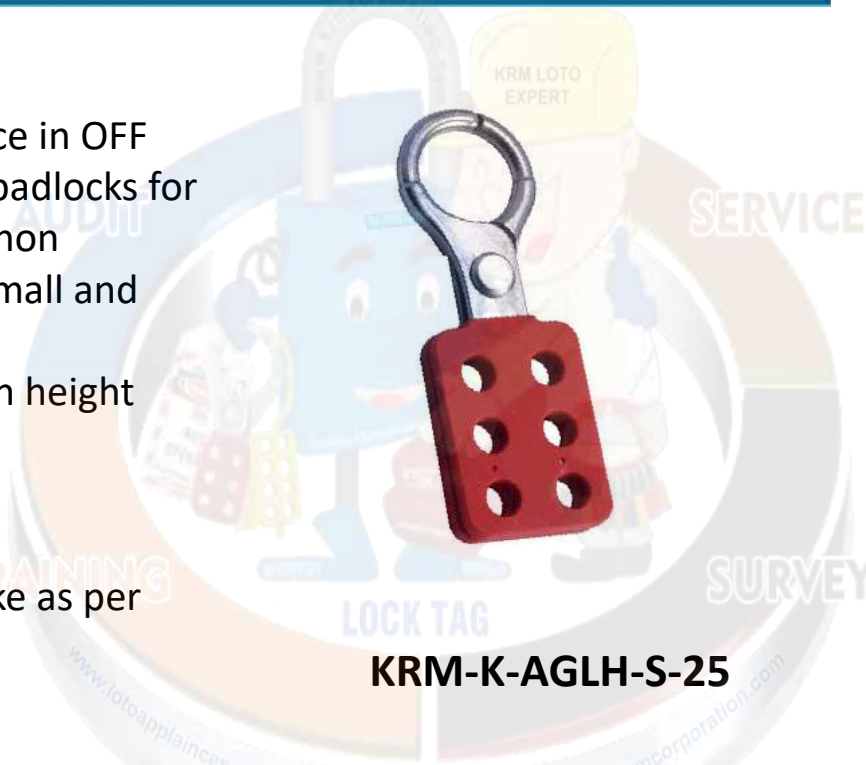

KRM-K-AGLH-S-25

Item code	Height	Jaw Size Dia	Padlock Hole Dia	No of holes	Weight
KRM-K-AGLH-S-25	113mm	25mm	10mm	06	70gm



OEM Manufacturer & Global Supplier of
Lockout Tagout & Safety Products

to meet
OSHA'S Lockout Tagout Standard
29 CFR, 1910.147&1910.269



www.lockoutappliances.com



Regd. Office: 1H/31-A, N.I.T, Faridabad-121001 (Haryana) Postal Office: 615, Sector-15-A, Faridabad-121007-Haryana-NCR-INDIA

www.krmcorporation.com | www.lockouttagouts.com | www.krmloto.com | www.locktagindia.com | www.lotoappliances.com

LOCKOUT/TAGOUT



ALUMINIUM GROUP LOCKOUT HASP

KRM LOTO
EXPERT

CE
Certified

- **Material** - Aluminium with Vinyl Coated at Grip
- KRM LOTO Vinyl coated Hasp is used to lock the device in OFF position OR permanent ON position accepts up to six padlocks for group Isolation with de energized insulated grip and non sparking Aluminum. Available in two different sizes small and premier.
- **Dimension** – Jaw diameter 25 mm for small hasp with height 113 mm Jaw diameter 38/39 mm for premier hasp with height 128 mm
- **Weight** – 70 gm for small hasp & 80 gm for premier hasp
- **Color** – Red, Yellow, Green and Blue or any color make as per the required quantity



KRM-K-AGLH-S-25 KRM-K-AGLH-P-38/39

ITEM CODE	OUTER HEIGHT	JAW SIZE DIA	HOLE SIZE	NO. OF HOLES	Weight
KRM-K-AGLH-S-25	113mm	25mm	10mm	06	70gm
KRM-K-AGLH-P-38/39	128mm	38mm	10mm	06	80gm



KRM LOTO ALUMINUM GROUP LOCKOUT HASP - JAW DIA 38 MM

- **Material** –Aluminium with Vinyl coated at grip
- KRM LOTO Vinyl coated Hasp is used to lock the device in OFF position OR permanent ON position accepts up to six padlocks for group Isolation with di-energized insulated grip and non sparking Aluminum. Available in two different sizes small and premier.
- **Dimension** – Jaw diameter 38 mm for Premier hasp with height 128 mm
- **Weight** – 80 gm
- No. of Holes – 6
- **Color** – Red, Yellow, Green and Blue Or any color make as per the required quantity

**KRM-K-AGLH-P-38/39**

Item code	Height	Jaw Size Dia	Padlock Hole Dia	No of holes	Weight
KRM-K-AGLH-P-38/39	128mm	38mm	10mm	06	80gm



OEM Manufacturer & Global Supplier of
Lockout Tagout & Safety Products

to meet
OSHA'S Lockout Tagout Standard
29 CFR, 1910.147&1910.269



www.lockoutappliances.com



Regd. Office: 1H/31-A, N.I.T, Faridabad-121001 (Haryana) | Postal Office: 615, Sector-15-A, Faridabad-121007-Haryana-NCR-INDIA

www.krmcorporation.com | www.lockouttagouts.com | www.krmloto.com | www.locktagindia.com | www.lotoappliances.com

LOCKOUT/TAGOUT



ALUMINIUM GROUP LOCKOUT HASP

KRM LOTO
EXPERT

CE
Certified

- **Material** - Aluminium with Vinyl Coated at Grip
- KRM LOTO Vinyl coated Hasp is used to lock the device in OFF position OR permanent ON position accepts up to six padlocks for group Isolation with de energized insulated grip and non sparking Aluminum. Available in two different sizes small and premier.
- **Dimension** – Jaw diameter 25 mm for small hasp with height 113 mm Jaw diameter 38/39 mm for premier hasp with height 128 mm
- **Weight** – 70 gm for small hasp & 80 gm for premier hasp
- **Color** – Red, Yellow, Green and Blue or any color make as per the required quantity



KRM-K-AGLH-S-25 KRM-K-AGLH-P-38/39

ITEM CODE	OUTER HEIGHT	JAW SIZE DIA	HOLE SIZE	NO. OF HOLES	Weight
KRM-K-AGLH-S-25	113mm	25mm	10mm	06	70gm
KRM-K-AGLH-P-38/39	128mm	38mm	10mm	06	80gm

GSTIN No.: 06AAMPW8746Q1Z6,
PAN No.: AAVPW8746Q
TIN No.: 06821328889,
TAN no.: RTKKO3359G
IEC: 0509006116

M: 00 91 9810 291 381, 8900 544 881



OEM Manufacturer & Global Supplier of
Lockout Tagout & Safety Products

to meet
OSHA'S Lockout Tagout Standard
29 CFR, 1910.147&1910.269



www.lotoappliances.com



GSTIN No.: 06AAECK2831L1Z1
PAN No.: AAECK2831L
TIN No.: 06824000112
CIN No.: U31903HR2011PTC042508
IEC: AAECK2831L

Telefax: 00 91 129 4021 381, 413 1381 (D)

Regd. Office: 1H/31-A, N.I.T, Faridabad-121001 (Haryana) | Postal Office: 615, Sector-15-A, Faridabad-121007-Haryana-NCR-INDIA

www.krmcorporation.com | www.lockouttagouts.com | www.krmloto.com | www.locktagindia.com | www.lotoappliances.com

KRM LOTO ALUMINUM GROUP LOCKOUT HASPS IN RED COLOR - JAW DIA 25 MM

- **Material** –Aluminum with powder coated.
- KRM LOTO Vinyl coated Hasp is used to lock the device in OFF position OR permanent ON position accepts up to six padlocks for group Isolation with di-energized insulated grip and non sparking Aluminium. Available in two different sizes small and premier.
- **Dimension** – Jaw diameter 25 mm for small hasp with height 113 mm
- **Weight** – 70 gm
- No. of Holes – 6
- **Color** – Red, Yellow, Green and Blue or any color make as per the required quantity



KRM-K-PAGLH-P-25

Item code	Height	Jaw Size Dia	Padlock Hole Dia	No of holes	Weight
KRM-K-PAGLH-P-25	113mm	25mm	10mm	06	70gm

KRM CORPORATION
 ISO 9001 - 9001:2015, ISO 14001 - 14001:2015, ISO 45001 - 45001:2018
 GSTIN No.: 06AAVPW8746Q1Z6,
 PAN No.: AAVPW8746Q
 TIN No.: 06821328889,
 TAN no.: RTKKO3359G
 IEC: 0509006116



KRM **Lock Tag!**
 OEM Manufacturer & Global Supplier of
 Lockout Tagout & Safety Products
 to meet
 OSHA'S Lockout Tagout Standard
 29 CFR, 1910.147&1910.269



KM Safetech Private Limited
 QUALITY MANAGEMENT SYSTEM ISO 9001:2015
 GSTIN No.: 06AAECK2831L1Z1
 PAN No.: AAECK2831L
 TIN No.: 06824000112
 CIN No.: U31903HR2011PTC042508
 IEC: AAECK2831L

M: 00 91 9810 291 381, 8800 544 881

Email: info@krmlo.com, info@krmcorporation.com, krmlo@gmail.com

Regd. Office: 1H/31-A, N.I.T, Faridabad-121001 (Haryana) Postal Office: 615, Sector-15-A, Faridabad-121007-Haryana-NCR-INDIA

Telefax: 00 91 129 4021 381, 413 1381 (D)

www.krmcorporation.com | www.lockouttagouts.com | www.krmlo.com | www.locktagindia.com | www.lotoappliances.com

LOCKOUT/TAGOUT



KRM-LOTO
 SAFETY PRODUCTS
safe loto

ALUMINIUM GROUP LOCKOUT HASP

KRM LOTO
 EXPERT
 CE
 Certified



- **Material** - Aluminium with powder coated.
- KRM LOTO Vinyl coated Hasp is used to lock the device in OFF position OR permanent ON position accepts up to six padlocks for group Isolation with di-energized insulated grip and non sparking Aluminum. Available in two different sizes small and premier.
- **Dimension** - Jaw diameter 25 mm for small hasp with height 113 mm Jaw diameter 38/39 mm for premier hasp with height 128 mm
- **Weight** - 70gm for small hasp & 80gm for premier hasp
- **Color** - Red, Yellow, Green and Blue or any color make as per the required quantity

ITEM CODE	OUTER HEIGHT	JAW SIZE DIA	HOLE SIZE	NO. OF HOLES	Weight
KRM-K-PAGLH-S-25	113mm	25mm	10mm	06	70gm
KRM-K-PAGLH-P-38/39	128mm	38mm	10mm	06	80gm

KRM-K-PAGLH-S-25 KRM-K-PAGLH-P-38/39

KRM CORPORATION
 ISO 9001 - 9001:2015, ISO 14001:2015, ISO 45001:2018
 to meet OSHA'S Lockout Tagout Standard 29 CFR, 1910.147&1910.269

KM Safetech Private Limited
 QUALITY MANAGEMENT SYSTEM ISO 9001:2015
 info@krmcorporation.com, info@krmlo.com, krmlo@gmail.com, wadhwarajinder@gmail.com

M: 00 91 9810 291 381, 8800 544 881, T: 00 91 129 - 4021 381

Postal Add: 615, Sector-15A, Faridabad-121007 Haryana - NCR (INDIA)
 Regd. Office: 1H/31A, N.I.T. Faridabad-121001

www.krmlo.com | www.krmcorporation.com, www.safetyloto.com
 www.lotoappliances.com, www.lockouttagouts.com





OEM Manufacturer & Global Supplier of
Lockout Tagout & Safety Products

to meet
OSHA'S Lockout Tagout Standard
29 CFR, 1910.147&1910.269



www.lotoappliances.com



KRM LOTO ALUMINIUM GROUP LOCKOUT HASPS IN RED COLOR - JAW DIA 38 MM

- **Material** –Aluminium with powder coated
- KRM LOTO Vinyl coated Hasp is used to lock the device in OFF position OR permanent ON position accepts up to six padlocks for group Isolation with di-energized insulated grip and non sparking Aluminium. Available in two different sizes small and premier.
- **Dimension** – Jaw diameter 38 mm for Premier hasp with height 128 mm
- **Weight** – 80 gm
- **No. of Holes** – 6
- **Color** – Red, Yellow, Green and Blue Or any color make as per the required quantity



KRM-K-PAGLH-P-38/39

Item code	Height	Jaw Size Dia	Padlock Hole Dia	No of holes	Weight
KRM-K-PAGLH-P-38/39	128mm	38mm	10mm	06	80gm



OEM Manufacturer & Global Supplier of
Lockout Tagout & Safety Products

to meet
OSHA'S Lockout Tagout Standard
29 CFR, 1910.147&1910.269



www.lockouttagouts.com



Regd. Office: 1H/31-A, N.I.T, Faridabad-121001 (Haryana) | Postal Office: 615, Sector-15-A, Faridabad-121007-Haryana-NCR-INDIA

www.krmcorporation.com | www.lockouttagouts.com | www.krmloto.com | www.locktagindia.com | www.lotoappliances.com

LOCKOUT/TAGOUT



ALUMINIUM GROUP LOCKOUT HASP

KRM LOTO
EXPERT

CE
Certified



- Material - Aluminium with powder coated.
- KRM LOTO Vinyl coated Hasp is used to lock the device in OFF position OR permanent ON position accepts up to six padlocks for group Isolation with di-energized insulated grip and non sparking Aluminum. Available in two different sizes small and premier.
- **Dimension** – Jaw diameter 25 mm for small hasp with height 113 mm Jaw diameter 38/39 mm for premier hasp with height 128 mm
- **Weight** – 70gm for small hasp & 80gm for premier hasp
- **Color** – Red, Yellow, Green and Blue or any color make as per the required quantity

ITEM CODE	OUTER HEIGHT	JAW SIZE DIA	HOLE SIZE	NO. OF HOLES	Weight
KRM-K-PAGLH-S-25	113mm	25mm	10mm	06	70gm
KRM-K-PAGLH-P-38/39	128mm	38mm	10mm	06	80gm

KRM-K-PAGLH-S-25 KRM-K-PAGLH-P-38/39



OEM Manufacturer & Global Supplier of
 Lockout Tagout & Safety Products

to meet
 OSHA'S Lockout Tagout Standard
 29 CFR, 1910.147&1910.269



www.lockoutappliances.com



KRM LOTO LABELED HASP - ALUMINIUM BASE SHEET

- **Material** – Aluminum with identifiable label.
- KRM LOTO Labeled Hasp is having 10 (multiple) holes so that multiple people can lock the equipment at a time, also writable printed label can be written by marker or re-writable pen.
- **Dimension** – Height -185mm, width -76mm, inside Jaw Diameter 25 x 38mm, huge upper jaw diameter 28 mm
- **Weight** – 180 gm.
- **Color** – Red, Yellow, Green, Blue any color make as per the required quantity



KRM-K-LTLH-AL-10

Item code	(A)	(B)	(C)	No of holes	Weight	Hole Size(F)	Type of Material Al=Aluminium
KRM-K-LTLH-AL-10	185mm	76mm	25x38mm	10	180gm	7.5mm	Al



OEM Manufacturer & Global Supplier of
Lockout Tagout & Safety Products

to meet
OSHA'S Lockout Tagout Standard
29 CFR, 1910.147&1910.269



www.lotoappliances.com



Regd. Office: 1H/31-A, N.I.T, Faridabad-121001 (Haryana) Postal Office: 615, Sector-15-A, Faridabad-121007-Haryana-NCR-INDIA

www.krmcorporation.com | www.lockouttagouts.com | www.krmloto.com | www.locktagindia.com | www.lotoappliances.com

LOCKOUT/TAGOUT



LABELED HASP - ALUMINIUM BASE SHEET

CE Certified

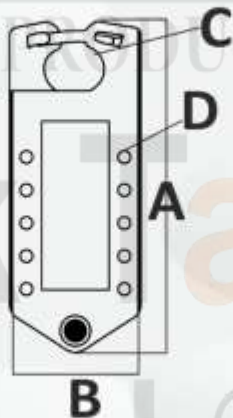

- Material – Aluminum with identifiable label.
- KRM LOTO Labeled Hasp is having 10 (multiple) holes so that multiple people can lock the equipment at a time, also writable printed label can be written by marker or re-writable pen.
- Dimension – Height -185mm, width -76mm, inside Jaw Diameter 25 x 38mm, huge upper jaw diameter 28 mm
- Weight – 180 gm.
- Color – Red, Yellow, Green, Blue any color make as per the required quantity

Item Code	(A)	(B)	(C)	Number of Hole (D)	Weight	Hole Size	Type of Material
KRM-K-LTLH-AL-10	185mm	76mm	25X38mm	06	180gm	7.5mm	AL



OEM Manufacturer & Global Supplier of
Lockout Tagout & Safety Products

to meet
OSHA'S Lockout Tagout Standard
29 CFR, 1910.147&1910.269



www.lockouttagouts.com



KRM LOTO LABELED HASP WITH 6 HOLES - ONE SIDE ONLY - POWDER COATED METAL BASE SHEET

- **Material** – hardened metal steel with powder coating and printed label.
- KRM LOTO Labeled Hasp is having 6 holes so that multiple people can lock the equipment at a time, also writable printed label can be written by marker or re-writable pen.
- **Dimension** – Height -185mm, width -76mm, inside Jaw Diameter 25 x 38mm, huge upper jaw diameter 28 mm
- **Height** – 191 mm
- **Weight** – 180gm.
- **Holes** – 6
- **Color** – Red, Yellow, Green, Blue any color make as per the required quantity

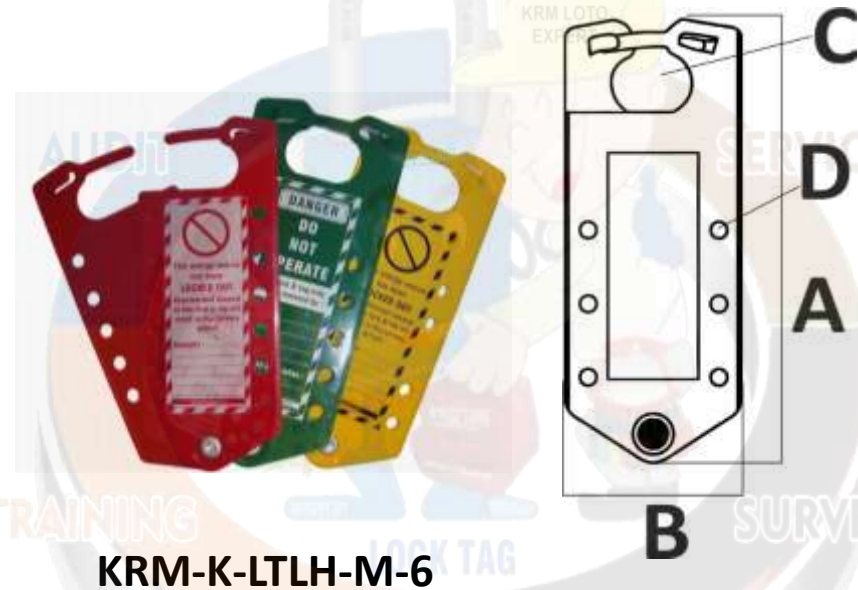

KRM-K-LTLH-M-6

Item code	height (A)	width (B)	Diameter (C)	No of holes	Weight	Hole Size(F)	Type of Material M=Mildsteel
KRM-K-LTLH-M-06	185mm	76mm	25X30mm	06	180gm	7.5mm	M



OEM Manufacturer & Global Supplier of
Lockout Tagout & Safety Products

to meet
OSHA'S Lockout Tagout Standard
29 CFR, 1910.147&1910.269



www.lockoutappliances.com



LOCKOUT/TAGOUT



LABELED HASP WITH 6,8,10,12,16 HOLES - POWDER COATED METAL BASE SHEET

CE Certified

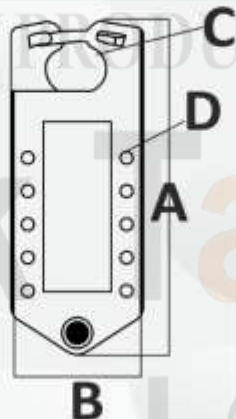

- **Material** – Mild stainless steel with powder coating and printed label
- **KRM LOTO Labeled Hasp** is having ten holes so that multiple people can lock the equipment at a time, also writable printed label can be written by marker or re-writable pen.
- **Color** – Red, Yellow, Green, Blue and metallic white
Or any color make as per the required quantity
- **Dimension** – length 7.25", width 3", inside Jaw Diameter 1" x 1.5", huge upper jaw diameter 28 mm
- **Height** – 191 mm
- **Weight** – 180 gm.



Item Code	(A)	(B)	(C)	Number of Hole (D)	(E)	Hole Size (F)	Type of Material M=Mildsteel
KRM-K-LTLH-M-06	191mm	76mm	25X30mm	06	07gm	7.5mm	M
KRM-K-LTLH-M-08	191mm	76mm	25X30mm	08	07gm	7.5mm	M
KRM-K-LTLH-M-10	191mm	76mm	25X30mm	10	07gm	7.5mm	M
KRM-K-LTLH-M-12	191mm	76mm	25X30mm	14	07gm	7.5mm	M
KRM-K-LTLH-M-16	191mm	76mm	25X30mm	16	07gm	7.5mm	M

GSTIN No.: 06AACPW8746Q1Z6,
PAN No.: AACPW8746Q
TIN No.: 06821328889,
TAN no.: RTKKO3359G
IEC: 0509006116

M: 00 91 9810 291 381, 8900 544 881



OEM Manufacturer & Global Supplier of
Lockout Tagout & Safety Products

to meet
OSHA'S Lockout Tagout Standard
29 CFR, 1910.147&1910.269



www.lockouttagouts.com



GSTIN No.: 06AAECK2831L1Z1
PAN No.: AAECK2831L
TIN No.: 06824000112
CIN No.: U31903HR2011PTC042508
IEC: AAECK2831L

Telefax: 00 91 129 4021 381, 413 1381 (D)

Regd. Office:1H/31-A, N.I.T, Faridabad-121001 (Haryana) Postal Office:615, Sector-15-A, Faridabad-121007-Haryana-NCR-INDIA

www.krmcorporation.com | www.lockouttagouts.com | www.krmloto.com | www.locktagindia.com | www.lotoappliances.com

KRM LOTO LABELED HASP WITH 8 HOLES - POWDER COATED METAL BASE SHEET

- Material** – hardened metal steel with powder coating and printed label
- KRM LOTO Labeled Hasp is having 8 holes so that multiple people can lock the equipment at a time, also writable printed label can be written by marker or re-writable pen.
- Dimension** – Height -185mm, width -76mm, inside Jaw Diameter 25 x 38mm, huge upper jaw diameter 28 mm
- Weight** – 180 gm.
- Holes** – 8
- Color** – Color – Red, Yellow, Green, Blue any color make as per the required quantity

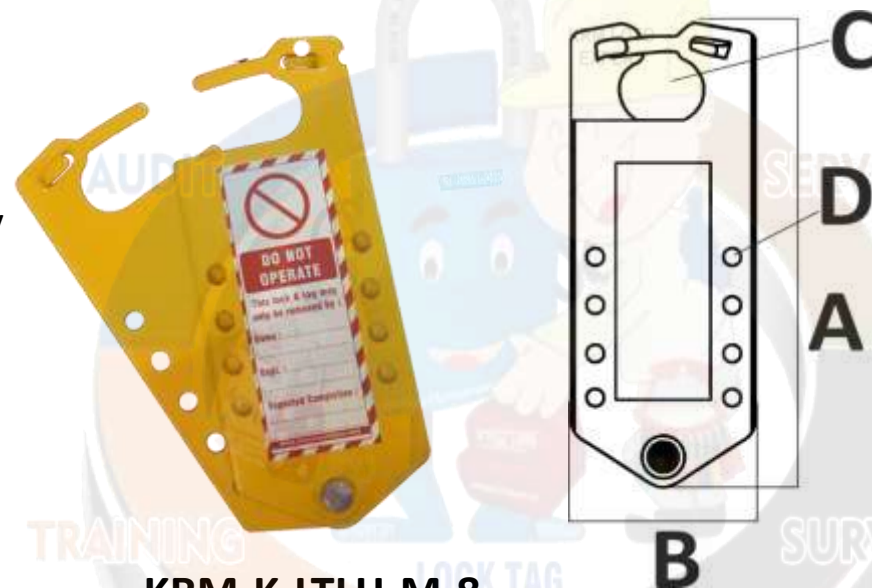

KRM-K-LTLH-M-8

Item code	height (A)	width (B)	Diameter (C)	No of holes	Weight	Hole Size(F)	Type of Material M=Mildsteel
KRM-K-LTLH-M-08	185mm	76mm	25X30mm	08	180gm	7.5mm	M



OEM Manufacturer & Global Supplier of
Lockout Tagout & Safety Products

to meet
OSHA'S Lockout Tagout Standard
29 CFR, 1910.147&1910.269



www.locktagindia.com



LOCKOUT/TAGOUT



**LABELED HASP WITH 6,8,10,12,16 HOLES - POWDER
COATED METAL BASE SHEET**

CE
Certified

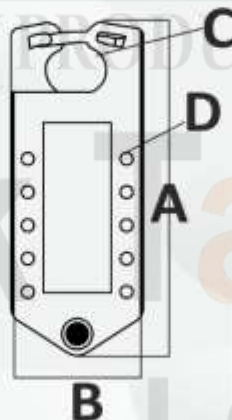

- Material – Mild stainless steel with powder coating and printed label
- KRM LOTO Labeled Hasp is having ten holes so that multiple people can lock the equipment at a time, also writable printed label can be written by marker or re-writable pen.
- Color – Red, Yellow, Green, Blue and metallic white
Or any color make as per the required quantity
- Dimension – length 7.25", width 3", inside Jaw Diameter 1" x 1.5", huge upper jaw diameter 28 mm
- Height – 191 mm
- Weight – 180 gm.



Item Code	(A)	(B)	(C)	Number of Hole (D)	(E)	Hole Size (F)	Type of Material M=Mildsteel
KRM-K-LTLH-M-06	191mm	76mm	25X30mm	06	07gm	7.5mm	M
KRM-K-LTLH-M-08	191mm	76mm	25X30mm	08	07gm	7.5mm	M
KRM-K-LTLH-M-10	191mm	76mm	25X30mm	10	07gm	7.5mm	M
KRM-K-LTLH-M-12	191mm	76mm	25X30mm	14	07gm	7.5mm	M
KRM-K-LTLH-M-16	191mm	76mm	25X30mm	16	07gm	7.5mm	M

GSTIN No.: 06AAVPW8746Q1Z6,
PAN No.: AAVPW8746Q
TIN No.: 06821328889,
TAN no.: RTKKO3359G
IEC: 0509006116

M: 00 91 9810 291 381, 8900 544 881



OEM Manufacturer & Global Supplier of
Lockout Tagout & Safety Products

to meet
OSHA'S Lockout Tagout Standard
29 CFR, 1910.147&1910.269



www.lotoappliances.com



GSTIN No.: 06AAECK2831L1Z1
PAN No.: AAECK2831L
TIN No.: 06824000112
CIN No.: U31903HR2011PTC042508
IEC: AAECK2831L

Telefax: 00 91 129 4021 381, 413 1381 (D)

Regd. Office: 1H/31-A, N.I.T, Faridabad-121001 (Haryana) | Postal Office: 615, Sector-15-A, Faridabad-121007-Haryana-NCR-INDIA

www.krmcorporation.com | www.lockouttagouts.com | www.krmloto.com | www.locktagindia.com | www.lotoappliances.com

KRM LOTO LABELED HASP WITH 10 HOLES - POWDER COATED METAL BASE SHEET

- **Material** – hardened metal steel with powder coating and identifiable label.
- KRM LOTO Labeled Hasp is having 10 holes so that multiple people can lock the equipment at a time, also writable printed label can be written by marker or re-writable pen.
- **Color** – Red, Yellow, Green, Blue any color make as per the required quantity
- **Dimension** – Height -185mm, width -76mm, inside Jaw Diameter 25 x 38mm, huge upper jaw diameter 28 mm
- **Height** – 191 mm
- **Weight** – 180 gm.

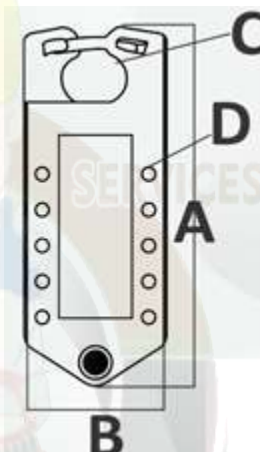

KRM-K-LTLH-M-10

Item code	height (A)	width (B)	Diameter (C)	No of holes	Weight	Hole Size(F)	Type of Material M=Mildsteel
KRM-K-LTLH-M-10	185mm	76mm	25X38mm	10	180gm	7.5mm	Al

GSTIN No.: 06AAVPW8746Q126,
PAN No.: AAVPW8746Q
TIN No.: 06821328889,
TAN no.: RTKKO3359G
IEC: 0509006116

M: 00 91 9810 291 381, 8800 544 881



OEM Manufacturer & Global Supplier of
Lockout Tagout & Safety Products

to meet
OSHA'S Lockout Tagout Standard
29 CFR, 1910.147&1910.269

www.lotoappliances.com



GSTIN No.: 06AAECK2831L1Z1
PAN No.: AAECK2831L
TIN No.: 06824000112
CIN No.: U31903HR2011PTC042508
IEC: AAECK2831L

Telefax: 00 91 129 4021 381, 413 1381 (D)

Regd. Office: 1H/31-A, N.I.T, Faridabad-121001 (Haryana) Postal Office: 615, Sector-15-A, Faridabad-121007-Haryana-NCR-INDIA

www.krmcorporation.com | www.lockouttagouts.com | www.krmloto.com | www.locktagindia.com | www.lotoappliances.com

LOCKOUT/TAGOUT



LABELED HASP WITH 6,8,10,12,16 HOLES - POWDER COATED METAL BASE SHEET

CE
Certified

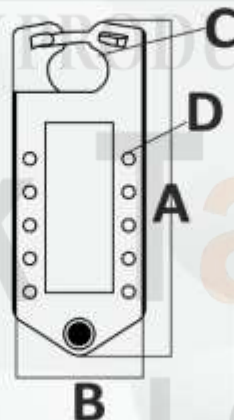

- Material – Mild stainless steel with powder coating and printed label
- KRM LOTO Labeled Hasp is having ten holes so that multiple people can lock the equipment at a time, also writable printed label can be written by marker or re-writable pen.
- Color – Red, Yellow, Green, Blue and metallic white
Or any color make as per the required quantity
- Dimension – length 7.25", width 3", inside Jaw Diameter 1" x 1.5", huge upper jaw diameter 28 mm
- Height – 191 mm
- Weight – 180 gm.



Item Code	(A)	(B)	(C)	Number of Hole (D)	(E)	Hole Size (F)	Type of Material M=Mildsteel
KRM-K-LTLH-M-06	191mm	76mm	25X30mm	06	07gm	7.5mm	M
KRM-K-LTLH-M-08	191mm	76mm	25X30mm	08	07gm	7.5mm	M
KRM-K-LTLH-M-10	191mm	76mm	25X30mm	10	07gm	7.5mm	M
KRM-K-LTLH-M-12	191mm	76mm	25X30mm	14	07gm	7.5mm	M
KRM-K-LTLH-M-16	191mm	76mm	25X30mm	16	07gm	7.5mm	M

KRM CORPORATION

OSHAS 18001:2007 & BS EN ISO 9001 : 2008 CERTIFIED
to meet OSHA's Lockout Tagout Standard 29 CFR, 1910.147 & 1910.269

Postal Add: 615, Sector-15A, Faridabad-121007
Regd. Office: 1H/31A, N.I.T. Faridabad-121001 Haryana - NCR (INDIA)

KRM Safetech Private Limited

M: 00 91 9810 291 381, 8800 544 881, T: 00 91 129 - 4021 381
info@krmcorporation.com, info@krmloto.com, krmloto@gmail.com, wadhwarajinder@gmail.com

www.krmloto.com | www.krmcorporation.com, www.safetyloto.com
www.lotoappliances.com, www.lockouttagouts.com

GSTIN No.: 06AAPPW8746Q126,
PAN No.: AAVPW8746Q
TIN No.: 06821328889,
TAN no.: RTKKO3359G
IEC: 0509006116

M: 00 91 9810 291 381, 8900 544 881



OEM Manufacturer & Global Supplier of
Lockout Tagout & Safety Products

to meet
OSHA'S Lockout Tagout Standard
29 CFR, 1910.147&1910.269



www.lockouttagouts.com



GSTIN No.: 06AAECK2831L1Z1
PAN No.: AAECK2831L
TIN No.: 06824000112
CIN No.: U31903HR2011PTC042508
IEC: AAECK2831L

Telefax: 00 91 129 4021 381, 413 1381 (D)

Regd. Office:1H/31-A, N.I.T, Faridabad-121001 (Haryana) Postal Office:615, Sector-15-A, Faridabad-121007-Haryana-NCR-INDIA

www.krmcorporation.com | www.lockouttagouts.com | www.krmloto.com | www.locktagindia.com | www.lotoappliances.com

KRM LOTO LABELED HASP WITH 12 HOLES - POWDER COATED METAL BASE SHEET

- **Material** – hardened metal steel with powder coating and printed label
- KRM LOTO Labeled Hasp is having 12 holes so that multiple people can lock the equipment at a time, also writable printed label can be written by marker or re-writable pen.
- **Dimension** – Height -185mm, width -76mm, inside Jaw Diameter 25 x 38mm, huge upper jaw diameter 28 mm
- **Weight** – 180 gm.
- **Holes** – 12
- **Color** – Red, Yellow, Green, Blue any color make as per the required quantity



KRM-K-LTLH-M-12

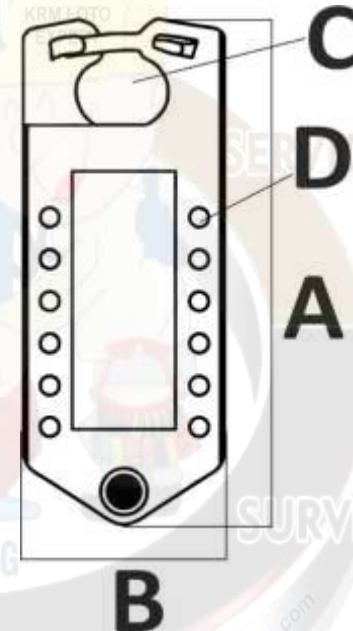

Item code	height (A)	width (B)	Diameter (C)	No of holes	Weight	Hole Size(F)	Type of Material M=Mildsteel AL=Aluminium
KRM-K-LTLH-M-12	185mm	76mm	25X38mm	12	180gm	7.5mm	M/Al



OEM Manufacturer & Global Supplier of
Lockout Tagout & Safety Products

to meet
OSHA'S Lockout Tagout Standard
29 CFR, 1910.147&1910.269



www.lotoappliances.com



GSTIN No.: 06AAECK2831L1Z1
PAN No.: AAECK2831L
TIN No.: 06824000112
CIN No.: U31903HR2011PTC042508
IEC: AAECK2831L

Telefax: 00 91 129 4021 381, 413 1381 (D)

www.krmcorporation.com

www.lockouttagouts.com

www.krmloto.com

www.locktagindia.com

www.lotoappliances.com

Regd. Office:1H/31-A, N.I.T, Faridabad-121001 (Haryana) Postal Office:615, Sector-15-A, Faridabad-121007-Haryana-NCR-INDIA

LOCKOUT/TAGOUT



LABELED HASP WITH 6,8,10,12,16 HOLES - POWDER COATED METAL BASE SHEET

CE Certified

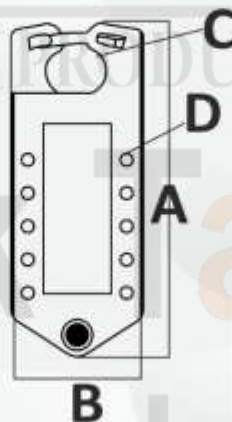

- Material – Mild stainless steel with powder coating and printed label
- KRM LOTO Labeled Hasp is having ten holes so that multiple people can lock the equipment at a time, also writable printed label can be written by marker or re- writable pen.
- Color – Red, Yellow, Green, Blue and metallic white Or any color make as per the required quantity
- Dimension – length 7.25", width 3", inside Jaw Diameter 1" x 1.5", huge upper jaw diameter 28 mm
- Height – 191 mm
- Weight – 180 gm.



Item Code	(A)	(B)	(C)	Number of Hole (D)	(E)	Hole Size (F)	Type of Material M=Mildsteel
KRM-K-LTLH-M-06	191mm	76mm	25X30mm	06	07gm	7.5mm	M
KRM-K-LTLH-M-08	191mm	76mm	25X30mm	08	07gm	7.5mm	M
KRM-K-LTLH-M-10	191mm	76mm	25X30mm	10	07gm	7.5mm	M
KRM-K-LTLH-M-12	191mm	76mm	25X30mm	14	07gm	7.5mm	M
KRM-K-LTLH-M-16	191mm	76mm	25X30mm	16	07gm	7.5mm	M

KRM CORPORATION

OSHAS 18001:2007 & BS EN ISO 9001 : 2008 CERTIFIED
to meet OSHA's Lockout Tagout Standard 29 CFR, 1910.147&1910.269

Postal Add: 615, Sector-15A, Faridabad-121007
Regd. Office: 1H/31A, N.I.T, Faridabad-121001 Haryana - NCR (INDIA)

KRM Safetech Private Limited

M: 00 91 9810 291 381, 8800 544 881, T: 00 91 129 - 4021 381
info@krmcorporation.com, info@krmloto.com, krmloto@gmail.com, wadhwarajinder@gmail.com

www.krmloto.com www.krmcorporation.com, www.safetyloto.com
www.lotoappliances.com, www.lockouttagouts.com



OEM Manufacturer & Global Supplier of
 Lockout Tagout & Safety Products

to meet
 OSHA'S Lockout Tagout Standard
 29 CFR, 1910.147&1910.269



www.lotoappliances.com



Regd. Office:1H/31-A, N.I.T, Faridabad-121001 (Haryana) | Postal Office:615, Sector-15-A, Faridabad-121007-Haryana-NCR-INDIA

www.krmcorporation.com | www.lockouttagouts.com | www.krmloto.com | www.locktagindia.com | www.lotoappliances.com

KRM LOTO LABELED HASP WITH 14 HOLES - POWDER COATED METAL BASE SHEET

- **Material** – hardened metal steel with powder coating and identifiable label.
- KRM LOTO Labeled Hasp is having 14 holes so that multiple people can lock the equipment at a time, also writable printed label can be written by marker or re-writable pen.
- **Color** – Red, Yellow, Green, Blue any color make as per the required quantity
- **Dimension** – Height -185mm, width -76mm, inside Jaw Diameter 25 x 38mm, huge upper jaw diameter 28 mm
- **Height** – 191 mm
- **Weight** – 180 gm.

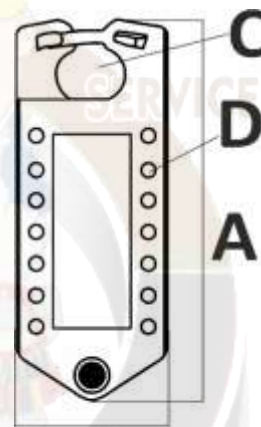

KRM-K-LTLH-M-14

Item code	height (A)	width (B)	Diameter (C)	No of holes	Weight	Hole Size(F)	Type of Material M=Mildsteel
KRM-K-LTLH-M-10	185mm	76mm	25X38mm	14	180gm	7.5mm	Al



OEM Manufacturer & Global Supplier of
Lockout Tagout & Safety Products

to meet
OSHA'S Lockout Tagout Standard
29 CFR, 1910.147&1910.269



www.lotoappliances.com



Regd. Office: 1H/31-A, N.I.T, Faridabad-121001 (Haryana) | Postal Office: 615, Sector-15-A, Faridabad-121007-Haryana-NCR-INDIA

www.krmcorporation.com | www.lockouttagouts.com | www.krmloto.com | www.locktagindia.com | www.lotoappliances.com

LOCKOUT/TAGOUT



LABELED HASP WITH 6,8,10,12,16 HOLES - POWDER COATED METAL BASE SHEET

CE Certified

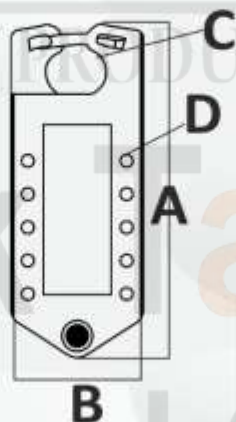

- Material – Mild stainless steel with powder coating and printed label
- KRM LOTO Labeled Hasp is having ten holes so that multiple people can lock the equipment at a time, also writable printed label can be written by marker or re-writable pen.
- Color – Red, Yellow, Green, Blue and metallic white
Or any color make as per the required quantity
- Dimension – length 7.25", width 3", inside Jaw Diameter 1" x 1.5", huge upper jaw diameter 28 mm
- Height – 191 mm
- Weight – 180 gm.



Item Code	(A)	(B)	(C)	Number of Hole (D)	(E)	Hole Size (F)	Type of Material M=Mildsteel
KRM-K-LTLH-M-06	191mm	76mm	25X30mm	06	07gm	7.5mm	M
KRM-K-LTLH-M-08	191mm	76mm	25X30mm	08	07gm	7.5mm	M
KRM-K-LTLH-M-10	191mm	76mm	25X30mm	10	07gm	7.5mm	M
KRM-K-LTLH-M-12	191mm	76mm	25X30mm	14	07gm	7.5mm	M
KRM-K-LTLH-M-16	191mm	76mm	25X30mm	16	07gm	7.5mm	M



OEM Manufacturer & Global Supplier of
 Lockout Tagout & Safety Products

to meet
 OSHA'S Lockout Tagout Standard
 29 CFR, 1910.147&1910.269

www.lockouttagouts.com



Regd. Office:1H/31-A, N.I.T, Faridabad-121001 (Haryana) Postal Office:615, Sector-15-A, Faridabad-121007-Haryana-NCR-INDIA

www.krmcorporation.com | www.lockouttagouts.com | www.krmloto.com | www.locktagindia.com | www.lotoappliances.com

KRM LOTO LABELED HASP WITH 16 HOLES - POWDER COATED METAL BASE SHEET

- **Material** – hardened metal steel with powder coating and printed label
- KRM LOTO Labeled Hasp is having 16 holes so that multiple people can lock the equipment at a time, also writable printed label can be written by marker or re-writable pen.
- **Dimension** – Height -185mm, width -76mm, inside Jaw Diameter 25 x 38mm, huge upper jaw diameter 28 mm
- **Weight** – 180 gm.
- **Holes** – 8
- **Color** – Color – Red, Yellow, Green, Blue any color make as per the required quantity



KRM-K-LTLH-M-16

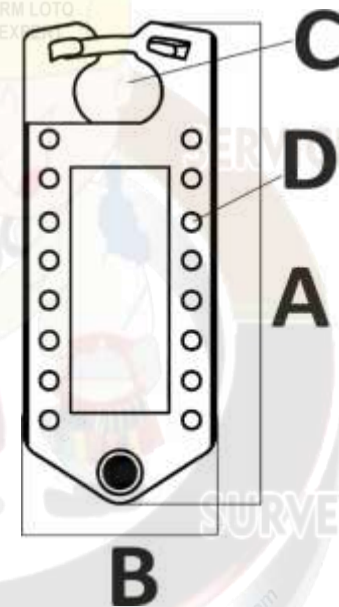

Item code	(A)	(B)	(C)	No of holes	Weight	Hole Size(F)	Type of Material M=Mildsteel
KRM-K-LTLH-M-16	185mm	76mm	25X38mm	16	180gm	7.5mm	M



OEM Manufacturer & Global Supplier of
Lockout Tagout & Safety Products

to meet
OSHA'S Lockout Tagout Standard
29 CFR, 1910.147&1910.269



www.lockoutappliances.com



LOCKOUT/TAGOUT



**LABELED HASP WITH 6,8,10,12,16 HOLES - POWDER
COATED METAL BASE SHEET**

CE
Certified

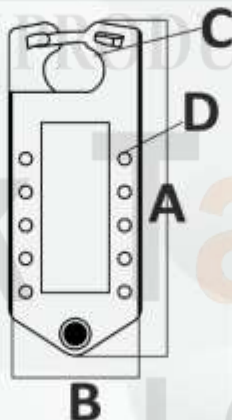

- Material – Mild stainless steel with powder coating and printed label
- KRM LOTO Labeled Hasp is having ten holes so that multiple people can lock the equipment at a time, also writable printed label can be written by marker or re-writable pen.
- Color – Red, Yellow, Green, Blue and metallic white
Or any color make as per the required quantity
- Dimension – length 7.25", width 3", inside Jaw Diameter 1" x 1.5", huge upper jaw diameter 28 mm
- Height – 191 mm
- Weight – 180 gm.



Item Code	(A)	(B)	(C)	Number of Hole (D)	(E)	Hole Size (F)	Type of Material M=Mildsteel
KRM-K-LTLH-M-06	191mm	76mm	25X30mm	06	07gm	7.5mm	M
KRM-K-LTLH-M-08	191mm	76mm	25X30mm	08	07gm	7.5mm	M
KRM-K-LTLH-M-10	191mm	76mm	25X30mm	10	07gm	7.5mm	M
KRM-K-LTLH-M-12	191mm	76mm	25X30mm	14	07gm	7.5mm	M
KRM-K-LTLH-M-16	191mm	76mm	25X30mm	16	07gm	7.5mm	M



OEM Manufacturer & Global Supplier of
 Lockout Tagout & Safety Products

to meet
 OSHA'S Lockout Tagout Standard
 29 CFR, 1910.147&1910.269



LOCKOUT LABELED HASP

- **Material** – Hardened Metal Steel & Aluminum with identifiable label.
- KRM LOTO Labeled Hasp is having (8,10,12) holes so that multiple people can lock the equipment at a time, also writable printed label can be written by marker or re-writable pen.
- **Dimension** – height 185mm, width 76, inside Jaw Diameter 25x38mm huge upper jaw diameter 28 mm
- **Weight** – 180 gm.
- **Color** – Red, Yellow, Green, Blue Or any color make as per the required quantity



Item code	(A)	(B)	(C)	No of holes	Weight	Hole Size(F)	Type of Material M=Mildsteel AL= Aluminium
KRM-K-LTLH-LBL	185mm	76mm	25X38mm	10	180gm	7.5mm	M/AL



OEM Manufacturer & Global Supplier of
Lockout Tagout & Safety Products

to meet
OSHA'S Lockout Tagout Standard
29 CFR, 1910.147&1910.269



www.lockoutappliance.com



LOCKOUT/TAGOUT



KRM LOTO
EXPERT

CE
Certified

LOCKOUT LABELED HASP

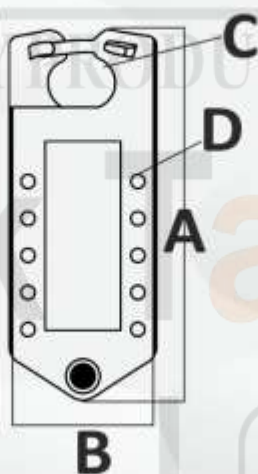

- **Material** – Hardened Metal Steel & Aluminum with identifiable label.
- KRM LOTO Labeled Hasp is having (8,10,12) holes so that multiple people can lock the equipment at a time, also writable printed label can be written by marker or re-writable pen.
- **Dimension** – height 185mm, width 76, inside Jaw Diameter 25x38mm huge upper jaw diameter 28 mm
- **Weight** – 180 gm.
- **Color** – Red, Yellow, Green, Blue Or any color make as per the required quantity



Item Code	(A)	(B)	(C)	Number of Hole (D)	Weight	Hole Size	Type of Material M= Mildsteel Al=Aluminium
KRM-K-LTLH-LBL	185mm	76mm	25X38mm	10	180gm	7.5mm	M/Al

GSTIN No.: 06AAMPW8746Q1Z6,
PAN No.: AAVPW8746Q
TIN No.: 06821328889,
TAN no.: RTKKO3359G
IEC: 0509006116

M: 00 91 9810 291 381, 8900 544 881



OEM Manufacturer & Global Supplier of
Lockout Tagout & Safety Products

to meet
OSHA'S Lockout Tagout Standard
29 CFR, 1910.147&1910.269



www.lotoappliances.com



GSTIN No.: 06AAECK2831L1Z1
PAN No.: AAECK2831L
TIN No.: 06824000112
CIN No.: U31903HR2011PTC042508
IEC: AAECK2831L

Telefax: 00 91 129 4021 381, 413 1381 (D)

Regd. Office: 1H/31-A, N.I.T, Faridabad-121001 (Haryana) Postal Office: 615, Sector-15-A, Faridabad-121007-Haryana-NCR-INDIA

www.krmcorporation.com | www.lockouttagouts.com | www.krmloto.com | www.locktagindia.com | www.lotoappliances.com

Notes:

- Lock & Tag should be used with all loto products
- For group locking on particular energy hasp should be used.
- Group lockout box should be used for group lockout tagout.
- Scissor Cable or Round cable lockout can be used to lock multiple hazardous energies instead putting individual locks & tags.
- Every equipment/machine should have provision for energy isolation
- Placards for the isolation (types of energies) of machine/equipment should be hanged/pasted near respective machine/equipment